



Superior[®] *Playgrounds*

2025 Product Catalog





Where play takes the lead.

At Superior, we help you transform ordinary play into a realm of limitless possibilities. Play takes the lead in our thoughtfully designed playgrounds, where every climb, slide, and swing is a pathway to growth and imagination.

Made in America



PLAY

made easy.



Play made easy — our mission, your joy.
We're dedicated to simplifying your playground experience.

We're one company providing all the products you need to build your outdoor playground space, including shades, pavilions, and site furniture.
Learn more at superiorrecreationalproducts.com.

Superior Playgrounds **Superior Shade** **Superior Shelter** **Superior Amenities**

Your local resource.

Our dedicated sales representatives are not just a voice on the phone, they're right where you are.

They stand ready to provide expert guidance and support, making your experience with us both convenient and tailored to your unique requirements. To start the ordering process, contact your local representative at srplayground.com/find-a-rep.

Helping you say goodbye to bidding and hello to contract pricing.

To help ease the strain of bid solicitation, Superior has opportunities for organizations to utilize national purchasing power by buying our products through reputable purchasing cooperatives. Learn more at srplayground.com/buying-cooperatives.



We telling your story.

SRP EX

A themed playground is like an open book, where every structure and element tells a unique story.

A playground is a canvas for storytelling. As children climb, swing, and slide, they're not just having fun — they're living out stories of bravery, discovery, and friendship. As experts in creating one-of-a-kind playgrounds, our team will work with you to tell the story of your community through a themed playground.

[View Our Designs on Page 32](#)



PLAY without barriers.

Providing inclusive play opportunities for a community is essential to ensure that every child of every ability can experience the joys of play and social interaction. Inclusive playgrounds promote empathy, break down barriers, and foster a sense of belonging among children of diverse abilities.

Inclusive Play Considerations

- 1 Access Points**
Provide multiple opportunities for individuals to independently access play and engage in intuitive play patterns.
- 2 Integration**
Include play events that children of all abilities can access throughout the play environment in order to encourage inclusion among all children.
- 3 Variety**
Offer a balance of play activities that support the physical, social-emotional, sensory, cognitive, and communicative needs of all children.

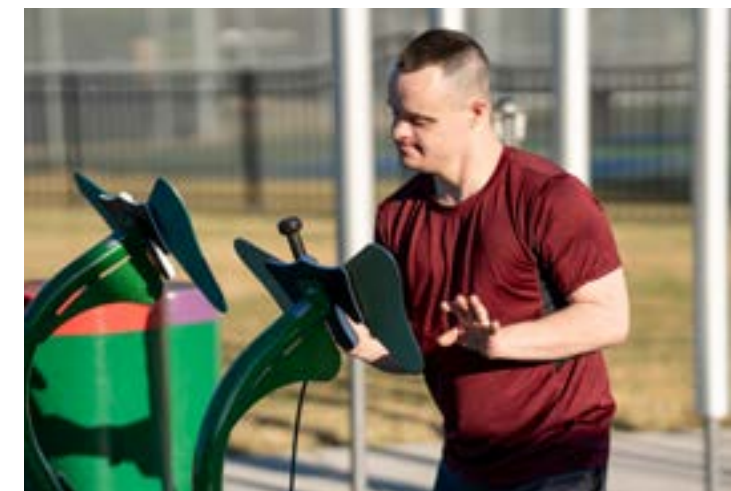

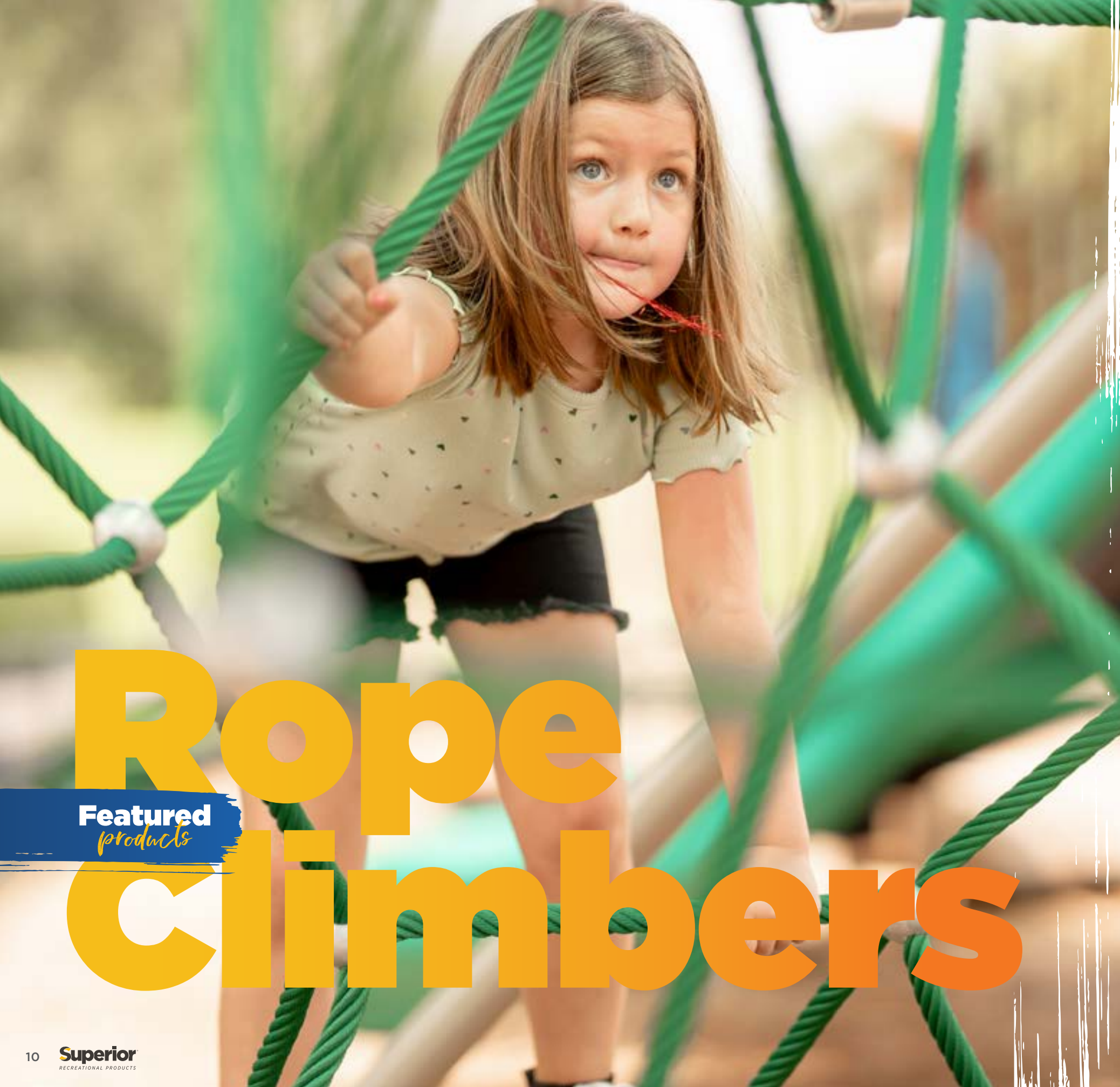

Rope Climbers

Featured products

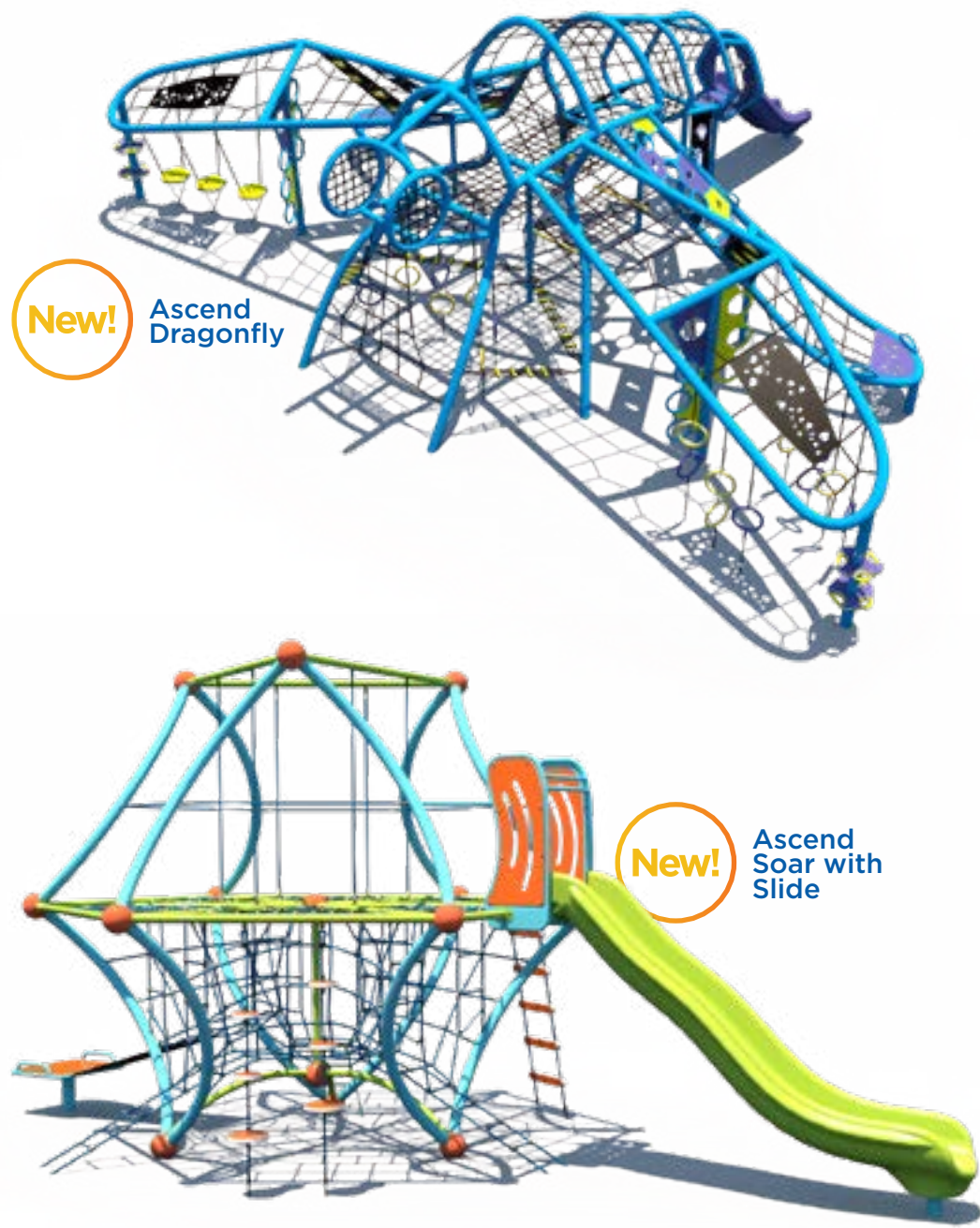

New! Ascend Dragonfly

New! Ascend Soar with Slide

Fun and challenging, our Ascend Rope Climbers bring adventure to any playground. With durable ropes and steel frames, they'll keep children moving while developing strength, coordination, and confidence.

[Learn more on page 116.](#)



Kaiju

Our new modular climbing system that expands play beyond deck limits.

Learn more on page 74.

PS5-73070



STEM-0008



SISTEM

Our new SISTEM panels are designed with 6 core benefits: sensory, interactive, science, technology, engineering, and math.

Learn more on page 135.



Products

Tower Series

Featured
products

The Tower Series offers an exhilarating experience that allows children to ascend to impressive heights while enjoying thrilling slides, challenging climbs, and panoramic views. These structures create an unforgettable environment for children to explore and conquer. These structures are designed fully enclosed with panels or barriers and meet ASTM standards for playground equipment.

[Learn more on page 66.](#)



FXT-WIR-512-0023

Age Group: 5-12 Years
Use Zone: 66' x 63'



Recycled Series

Featured
Products



Our recycled playground line, Grounds For Play®, has the natural look of wood but requires minimal maintenance. The posts and decks are made from reclaimed post-consumer plastic products like milk jugs. What's more, our recycled line focuses on early childhood development with play themes around dramatic play, nature play, art play, and more. You can also get all the benefits of this line through our themed recycled series.

Discover more at [groundsforplay.com](https://www.groundsforplay.com).



INFO0087XX
Ages: 6-23 Months
Use Zone: 17'6" x 19'3"





FXT-WIR-512-0023
Age Group: 5-12 Years
Use Zone: 66' x 63'



FXT-GEN-512-0035
Ages: 5-12 Years
Use Zone: 51' x 46'



Mitchell County Elementary School
Bakersville, North Carolina





FX5-NAT-512-0519
Ages: 5-12 Years
Use Zone: 47' x 41'



Hillside Elementary School
Allendale, New Jersey



FEATURED
Project



Acanthus Lane Park
Houston, Texas

PS3-71835
Age Group: 2-12 Years
Use Zone: 47' x 32'



FEATURED
project

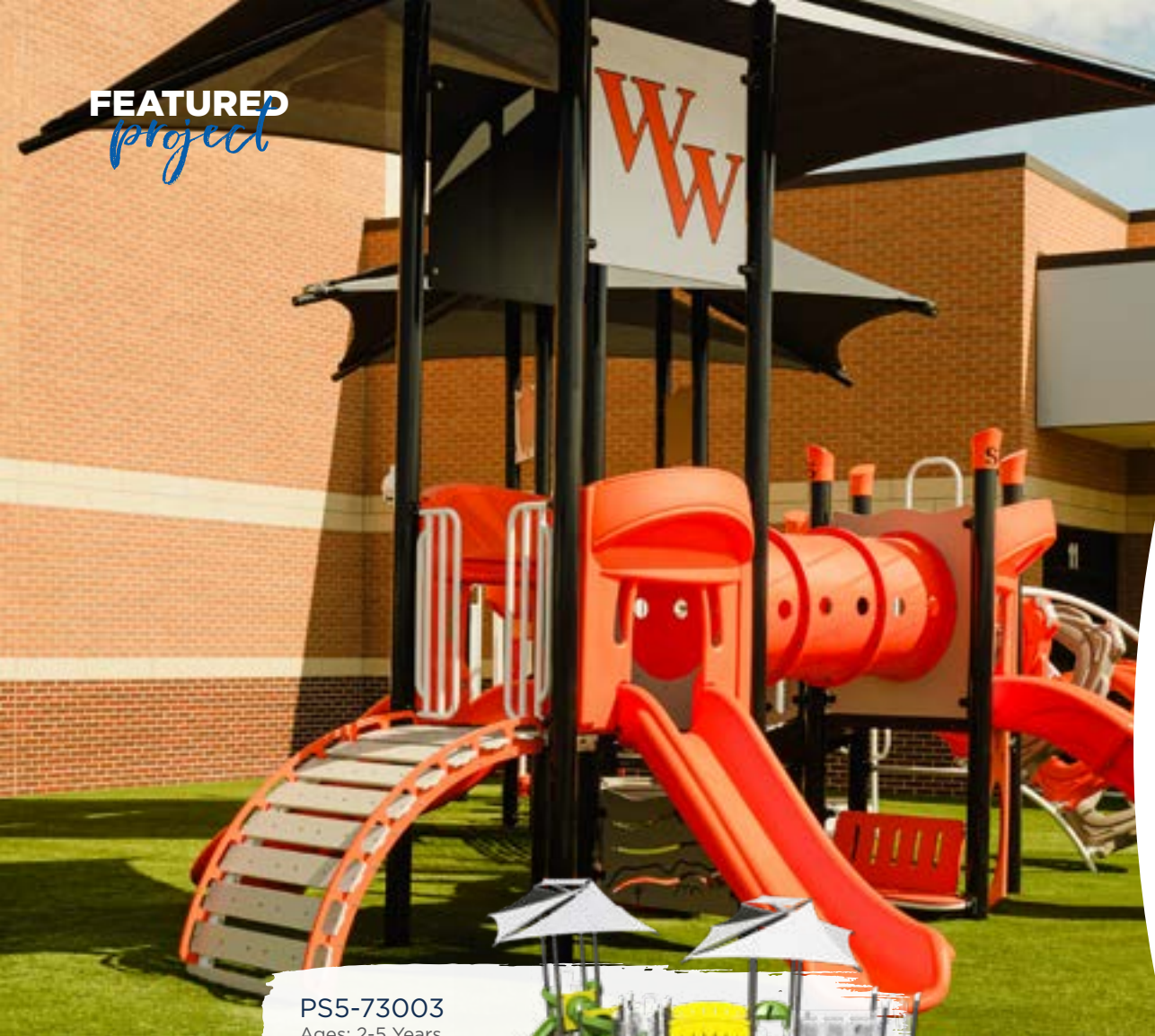

PS5-73003
Ages: 2-5 Years
Use Zone: 57' x 35'



Wink-Loving Elementary School
Wink, Texas





What's Inside



28
School-Age
Structures

A photograph of a school-age playground structure with red slides and railings, set on a sandy surface.

106
Early Childhood
Structures

A photograph of an early childhood playground structure with a green slide and blue railings.

114
Freestanding
Play

A photograph of a freestanding playground structure with a red slide and yellow railings.

152
Structure
Components

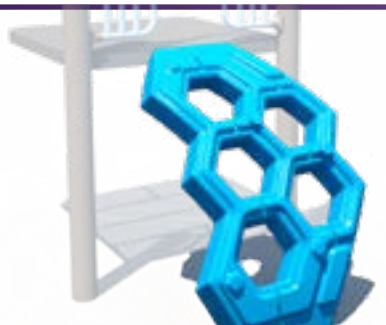
A photograph of a blue, hexagonal structure component.

174
Complete Your
Space

A photograph of a shaded play area with a black mat and blue railings.



Play Structures

- 32** Steel Themed Series
- 56** Recycled Themed Series
- 66** Tower Series
- 74** Kaiju
- 78** Classic Series: Ages 5-12
- 86** Classic Series: Ages 2-12
- 94** Classic Series: Ages 2-5
- 100** Active Series
- 104** Quick Ship



TAKE YOUR PICK

You want choices. We've got them — along with the design expertise to take your ideas and make them real. From long-lasting steel and recycled materials to an elaborate theme, we can combine your imagination with our expertise to reimagine the way children play.

All of our playgrounds feature a clean, no-clamp connection.

Themed Series
Ages 2-5, 2-12, 5-12

Tower Series
Ages 5-12

Kaiju Series
Ages 5-12

Adventure Series
Ages 2-5, 2-12, 5-12

Expedition Series
Ages 2-5, 2-12, 5-12

Active Series
Ages 5-12



Steel Themed SERIES

A themed playground is like an open book,
where every structure and element tells a
unique story.



CONCEPT TO CREATION

As experts in creating **one-of-a-kind** playgrounds, our creative design team has been trusted with designing themes ranging from space to the ocean floor — and different activities, objects, and locations in between.



Handcrafted in the USA, we're one of the premiere manufacturers that can create themed playgrounds in either steel or recycled material. From **concept to creation**, we will work together with you to tell the unique story of your community through our themed playgrounds.



New!

FX5-NAT-512-0519

Ages: 5-12 Years
Use Zone: 47' x 41'



FX5-NAT-212-0373

Ages: 2-12 Years
Use Zone: 57' x 47'



New!

FXT-NAT-512-0078

Ages: 5-12 Years
Use Zone: 62' x 56'
Deck Height: 13'



New!

FX5-NAT-512-0468

Ages: 5-12 Years
Use Zone: 75' x 64'

MODEL	AGES	CAPACITY	SIZE	USE ZONE	FALL HEIGHT	EST. TIMBER COUNT	ADA
FX5-NAT-512-0519	5-12	82	35' x 30'	47' x 41'	7'	38	Yes
FXT-NAT-512-0078	5-12	168	50' x 43'	62' x 56'	13'	51	Yes

MODEL	AGES	CAPACITY	SIZE	USE ZONE	FALL HEIGHT	EST. TIMBER COUNT	ADA
FX5-NAT-212-0373	2-12	130	45' x 36'	57' x 47'	7'	55	Yes
FX5-NAT-512-0468	5-12	235	69' x 51'	75' x 64'	7'	69	Yes

What's timber count? The amount of 4" playground timbers needed to surround the playground should a type of loose fill surfacing be used. See page 176 for more information.



FX5-NAT-512-0218
 Ages: 5-12 Years
 Use Zone: 42' x 35'



FX5-MAR-212-0108
 Ages: 2-12 Years
 Use Zone: 53' x 32'



New! **FX5-NAT-512-0389**
 Ages: 5-12 Years
 Use Zone: 56' x 44'



FX5-MAR-512-0372
 Ages: 5-12 Years
 Use Zone: 80' x 48'

MODEL	AGES	CAPACITY	SIZE	USE ZONE	FALL HEIGHT	EST. TIMBER COUNT	ADA
FX5-NAT-512-0218	5-12	85	30' x 23'	42' x 35'	6'	34	Yes
FX5-NAT-512-0389	5-12	86	43' x 31'	56' x 44'	8'	43	Yes

MODEL	AGES	CAPACITY	SIZE	USE ZONE	FALL HEIGHT	EST. TIMBER COUNT	ADA
FX5-MAR-212-0108	5-12	114	41' x 21'	53' x 32'	6'	40	Yes
FX5-MAR-512-0372	5-12	104	66' x 40'	80' x 48'	7'	61	Yes



FX5-MAR-212-0290
Ages: 2-12 Years
Use Zone: 35' x 25'



FX5-CAS-512-0465
Ages: 5-12 Years
Use Zone: 49' x 46'



FX5-NAT-212-0302
Ages: 2-12 Years
Use Zone: 45' x 39'



FX5-WST-512-0305
Ages: 5-12 Years
Use Zone: 56' x 42'



MODEL	AGES	CAPACITY	SIZE	USE ZONE	FALL HEIGHT	EST. TIMBER COUNT	ADA
FX5-MAR-212-0290	2-12	38	24' x 13'	35' x 25'	5'	24	Yes
FX5-NAT-212-0302	2-12	42	33' x 29'	45' x 39'	6'	34	Yes

MODEL	AGES	CAPACITY	SIZE	USE ZONE	FALL HEIGHT	EST. TIMBER COUNT	ADA
FX5-CAS-512-0465	5-12	104	36' x 35'	49' x 46'	6'	44	Yes
FX5-WST-512-0305	5-12	123	44' x 31'	56' x 42'	7'	48	Yes



FX5-WST-212-0309
 Ages: 2-12 Years
 Use Zone: 43' x 43'



FX5-CTL-512-0216
 Ages: 5-12 Years
 Use Zone: 39' x 35'



FX5-WST-512-0074
 Ages: 5-12 Years
 Use Zone: 49' x 33'



FXT-CTL-512-0072
 Ages: 5-12 Years
 Use Zone: 35' x 34'
 Deck Height: 10'

MODEL	AGES	CAPACITY	SIZE	USE ZONE	FALL HEIGHT	EST. TIMBER COUNT	ADA
FX5-WST-212-0309	2-12	87	31' x 30'	43' x 43'	6'	37	Yes
FX5-WST-512-0074	5-12	88	40' x 23'	49' x 33'	6'	38	Yes

MODEL	AGES	CAPACITY	SIZE	USE ZONE	FALL HEIGHT	EST. TIMBER COUNT	ADA
FX5-CTL-512-0216	5-12	58	27' x 23'	39' x 35'	6'	30	Yes
FXT-CTL-512-0072	5-12	39	24' x 19'	35' x 34'	10'	29	Yes



New! FX5-SPC-512-0082
Ages: 5-12 Years
Use Zone: 52' x 45'



FX5-EFR-212-0183
Ages: 2-12 Years
Use Zone: 45' x 35'
Customize Your Own Graphics!



New! FX5-AIR-512-0469
Ages: 5-12 Years
Use Zone: 51' x 40'



New! FX5-TRN-212-0418
Ages: 2-12 Years
Use Zone: 47' x 27'

MODEL	AGES	CAPACITY	SIZE	USE ZONE	FALL HEIGHT	EST. TIMBER COUNT	ADA
FX5-SPC-512-0082	5-12	104	38' x 32'	52' x 45'	8'	45	Yes
FX5-AIR-512-0469	5-12	88	39' x 28'	51' x 40'	8'	42	Yes

MODEL	AGES	CAPACITY	SIZE	USE ZONE	FALL HEIGHT	EST. TIMBER COUNT	ADA
FX5-EFR-212-0183	2-12	68	33' x 23'	45' x 35'	5'	33	Yes
FX5-TRN-212-0418	2-12	74	35' x 15'	47' x 27'	4'	32	Yes



FXT-EFR-512-0074
 Ages: 5-12 Years
 Use Zone: 58' x 32'
 Deck Height: 10'



FX5-EFR-212-0333
 Ages: 2-12 Years
 Use Zone: 36' x 30'



FX5-EFR-212-0162
 Ages: 2-12 Years
 Use Zone: 36' x 22'



FX5-SPT-212-0240
 Ages: 2-12 Years
 Use Zone: 52' x 41'

MODEL	AGES	CAPACITY	SIZE	USE ZONE	FALL HEIGHT	EST. TIMBER COUNT	ADA
FXT-EFR-512-0074	5-12	119	47' x 43'	58' x 32'	10'	42	Yes
FX5-EFR-212-0162	2-12	87	24' x 22'	36' x 22'	5'	30	Yes

MODEL	AGES	CAPACITY	SIZE	USE ZONE	FALL HEIGHT	EST. TIMBER COUNT	ADA
FX5-EFR-212-0333	2-12	54	24' x 20'	36' x 30'	4'	29	Yes
FX5-SPT-212-0240	2-12	85	42' x 29'	52' x 41'	6'	40	Yes



FX5-SPT-212-0265
 Ages: 2-12 Years
 Use Zone: 50' x 47'



FXT-CVL-512-0076
 Ages: 5-12 Years
 Use Zone: 58' x 57'
 Deck Height: 14'



FXT-SPT-512-0071
 Ages: 5-12 Years
 Use Zone: 66' x 57'
 Deck Height: 14'



FX5-CVL-212-0350
 Ages: 2-12 Years
 Use Zone: 69' x 41'

MODEL	AGES	CAPACITY	SIZE	USE ZONE	FALL HEIGHT	EST. TIMBER COUNT	ADA
FX5-SPT-212-0265	2-12	117	38' x 35'	50' x 47'	7'	43	Yes
FXT-SPT-512-0071	5-12	201	53' x 43'	66' x 57'	13'	51	Yes

MODEL	AGES	CAPACITY	SIZE	USE ZONE	FALL HEIGHT	EST. TIMBER COUNT	ADA
FXT-CVL-512-0076	5-12	168	46' x 43'	58' x 57'	13'	50	Yes
FX5-CVL-212-0350	2-12	199	56' x 29'	69' x 41'	6'	45	Yes

What's timber count? The amount of 4' playground timbers needed to surround the playground should a type of loose fill surfacing be used. See page 176 for more information.

Themed Economy Series

By using 3.5" posts, our themed economy series saves money without sacrificing on theming.

FX3-SHP-212-0007

Ages: 2-12 Years
Use Zone: 42' x 31'

Concept Only*



FX3-NAT-212-0005

Ages: 2-12 Years
Use Zone: 31' x 28'

Concept Only*



FX3-SHP-512-0008

Ages: 5-12 Years
Use Zone: 47' x 36'

Concept Only*



FX3-NAT-512-0006

Ages: 5-12 Years
Use Zone: 46' x 33'

Concept Only*



MODEL	AGES	CAPACITY	SIZE	USE ZONE	FALL HEIGHT	EST. TIMBER COUNT	ADA
FX3-SHP-212-0007	2-12	45	30' x 19'	42' x 31'	5'	30	Yes
FX3-SHP512-001	5-12	57	35' x 24'	47' x 36'	7'	36	Yes

MODEL	AGES	CAPACITY	SIZE	USE ZONE	FALL HEIGHT	EST. TIMBER COUNT	ADA
FX3-NAT-212-0005	2-12	27	19' x 16'	31' x 28'	5'	34	Yes
FX3-NAT-512-0006	5-12	40	34' x 21'	46' x 33'	7'	33	Yes

Themed Economy Series

FX3-FRM-212-0009

Ages: 2-12 Years
Use Zone: 33' x 29'

Concept Only*



Reverse View



FX3-FRM-512-0010

Ages: 5-12 Years
Use Zone: 44' x 38'

Concept Only*



Reverse View

FX3-CAS-212-0012

Ages: 2-12 Years
Use Zone: 33' x 24'

Concept Only*



Reverse View

FX3-CAS-512-0013

Ages: 5-12 Years
Use Zone: 37' x 36'

Concept Only*



Reverse View

MODEL	AGES	CAPACITY	SIZE	USE ZONE	FALL HEIGHT	EST. TIMBER COUNT	ADA
FX3-FRM-212-0009	2-12	33	17' x 21'	33' x 29'	5'	26	Yes
FX3-FRM-512-0010	5-12	42	30' x 24'	44' x 38'	8'	38	Yes

MODEL	AGES	CAPACITY	SIZE	USE ZONE	FALL HEIGHT	EST. TIMBER COUNT	ADA
FX3-CAS-212-0012	2-12	22	21' x 12'	33' x 24'	5'	24	Yes
FX3-CAS-512-0013	5-12	28	24' x 24'	37' x 36'	7'	31	Yes

Themed Economy Series

FX3-WST-205-0001

Ages: 2-5 Years
Use Zone: 31' x 29'



FX3-TRN-212-0015

Ages: 2-12 Years
Use Zone: 40' x 29'



FX3-WST-212-0002

Ages: 2-12 Years
Use Zone: 31' x 31'



FX3-TRN-512-0016

Ages: 5-12 Years
Use Zone: 53' x 27'



MODEL	AGES	CAPACITY	SIZE	USE ZONE	FALL HEIGHT	EST. TIMBER COUNT	ADA
FX3-WST-205-0001	2-5	29	19' x 17'	31' x 29'	4'	25	Yes
FX3-WST-212-0002	2-12	29	19' x 19'	31' x 31'	5'	26	Yes

MODEL	AGES	CAPACITY	SIZE	USE ZONE	FALL HEIGHT	EST. TIMBER COUNT	ADA
FX3-TRN-212-0015	2-12	41	28' x 16'	40' x 29'	6'	29	Yes
FX3-TRN-512-0016	5-12	51	39' x 16'	53' x 27'	8'	36	Yes



Recycled Themed SERIES

These structures combine the magic of theming with our recycled posts and decks. It has the natural look of wood without the unwanted maintenance.

R-Town[®] Cottages

FXR-COT-212-0157

Age Group: 2-12 Years
Use Zone: 44' x 37'



FXR-COT-205-0187

Age Group: 2-5 Years
Use Zone: 35' x 28'



Reverse View



FXR-COT-205-0156

Age Group: 2-5 Years
Use Zone: 32' x 28'



Reverse View



FXR-COT-205-0191

Age Group: 2-5 Years
Use Zone: 30' x 22'



Reverse View



FXR-COT-205-0169

Age Group: 2-5 Years
Use Zone: 37' x 36'

MODEL	AGES	CAPACITY	SIZE	USE ZONE	FALL HEIGHT	EST. TIMBER COUNT	ADA
FXR-COT-212-0157	2-12	82	32' x 25'	44' x 37'	6'	35	Yes
FXR-COT-205-0169	2-5	60-65	25' x 24'	37' x 36'	4'	31	Yes

MODEL	AGES	CAPACITY	SIZE	USE ZONE	FALL HEIGHT	EST. TIMBER COUNT	ADA
FXR-COT-205-0187	2-5	10-15	22' x 16'	35' x 28'	4'	27	Yes
FXR-COT-205-0156	2-5	45-50	20' x 16'	32' x 28'	4'	25	Yes
FXR-COT-205-0191	2-5	25-30	18' x 13'	30' x 22'	3'	22	Yes

What's timber count? The amount of 4" playground timbers needed to surround the playground should a type of loose fill surfacing be used. See page 176 for more information.

FXR-SHP-512-0076B
 Ages: 5-12 Years
 Use Zone: 59' x 34'



FXR-SHP-212-0091
 Ages: 2-12 Years
 Use Zone: 37' x 29'



FXR-SHP-205-0076A
 Ages: 2-5 Years
 Use Zone: 32' x 29'



New! **FXR-BCH-205-0186**
 Ages: 2-5 Years
 Use Zone: 33' x 29'



MODEL	AGES	CAPACITY	SIZE	USE ZONE	FALL HEIGHT	EST. TIMBER COUNT	ADA
FXR-SHP-512-0076B	5-12	129	44' x 22'	59' x 34'	8'	43	Yes
FXR-SHP-205-0076A	2-5	53	20' x 16'	32' x 29'	4'	24	Yes

MODEL	AGES	CAPACITY	SIZE	USE ZONE	FALL HEIGHT	EST. TIMBER COUNT	ADA
FXR-SHP-212-0091	2-12	47	25' x 17'	37' x 29'	6'	28	Yes
FXR-BCH-205-0186	2-5	35	21' x 17'	33' x 29'	4'	25	Yes



New! FXR-SHP-205-0180
Ages: 2-5 Years
Use Zone: 42' x 30'



FXR-NAT-512-0082
Ages: 5-12 Years
Use Zone: 43' x 38'



New! FXR-NAT-205-0030
Ages: 2-5 Years
Use Zone: 33' x 25'



FXR-FRM-205-0038
Ages: 2-5 Years
Use Zone: 34' x 27'



MODEL	AGES	CAPACITY	SIZE	USE ZONE	FALL HEIGHT	EST. TIMBER COUNT	ADA
FXR-SHP-205-0180	2-5	106	30' x 19'	42' x 30'	4'	31	Yes
FXR-NAT-205-0030	2-5	64	21' x 14'	33' x 25'	4'	25	Yes

MODEL	AGES	CAPACITY	SIZE	USE ZONE	FALL HEIGHT	EST. TIMBER COUNT	ADA
FXR-NAT-512-0082	5-12	99	31' x 28'	43' x 38'	6'	32	Yes
FXR-FRM-205-0038	2-5	35	22' x 15'	34' x 27'	4'	26	Yes



New! FXR-SPC-205-0131
Ages: 2-5
Use Zone: 44' x 41'



FXR-TRN-512-0029
Ages: 5-12 Years
Use Zone: 61' x 49'



FXR-TRN-212-0093
Ages: 2-12 Years
Use Zone: 45' x 32'



FXR-WST-212-0099



MODEL	AGES	CAPACITY	SIZE	USE ZONE	FALL HEIGHT	EST. TIMBER COUNT	ADA
FXR-SPC-205-0131	2-5	80	30' x 28'	44' x 41'	4'	36	Yes
FXR-TRN-212-0093	2-12	67	33' x 20'	45' x 32'	5'	32	Yes

MODEL	AGES	CAPACITY	SIZE	USE ZONE	FALL HEIGHT	EST. TIMBER COUNT	ADA
FXR-TRN-512-0029	5-12	120	49' x 37'	61' x 49'	7'	51	Yes
FXR-WST-212-0099	2-12	36	28' x 20'	40' x 32'	5'	30	Yes



Tower SERIES

Soaring to towering heights, our Tower Series features 5" steel posts and our tallest deck heights.



New! FXT-GEN-512-0006
Ages: 5-12 Years
Use Zone: 43' x 40'



FXT-WIR-512-0023
Age Group: 5-12 Years
Use Zone: 66' x 63'



New! FXT-GEN-512-0035
Ages: 5-12 Years
Use Zone: 51' x 46'



MODEL	AGES	CAPACITY	SIZE	USE ZONE	FALL HEIGHT	TOWER DECK HEIGHT	EST. TIMBER COUNT	ADA
FXT-GEN-512-0006	5-12	75	29' x 30'	43' x 40'	14'	14'	36	Yes
FXT-WIR-512-0023	5-12	109	54' x 49'	66' x 63'	14'	14'	62	Yes
FXT-GEN-512-0035	5-12	88	47' x 40'	51' x 46'	10'	10'	44	Yes

What's timber count? The amount of 4' playground timbers needed to surround the playground should a type of loose fill surfacing be used. See page 176 for more information.



New!

FXT-GEN-512-0007

Age Group: 5-12 Years
Use Zone: 40' x 38'

New!

FXT-GEN-512-0034

Ages: 5-12 Years
Use Zone: 59' x 53'

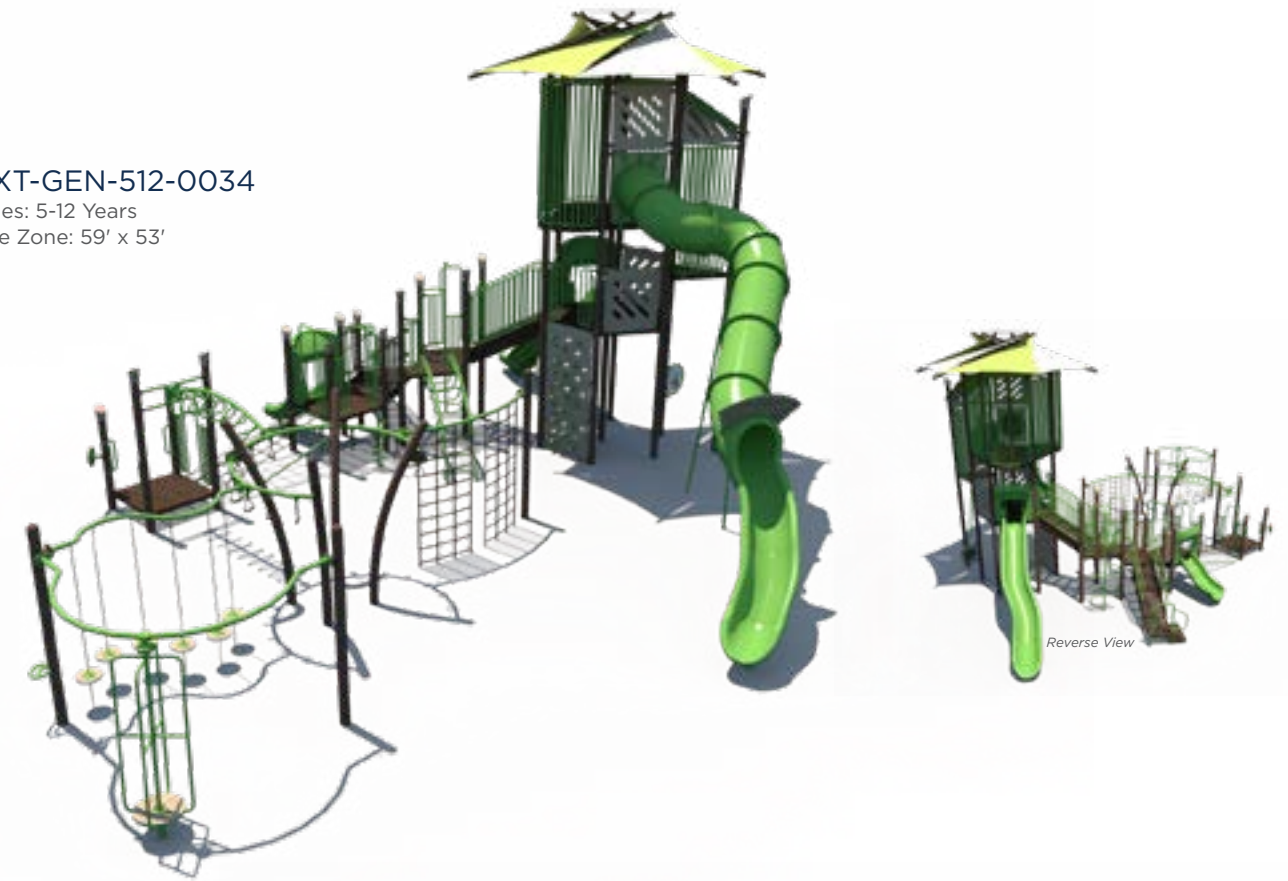

Reverse View

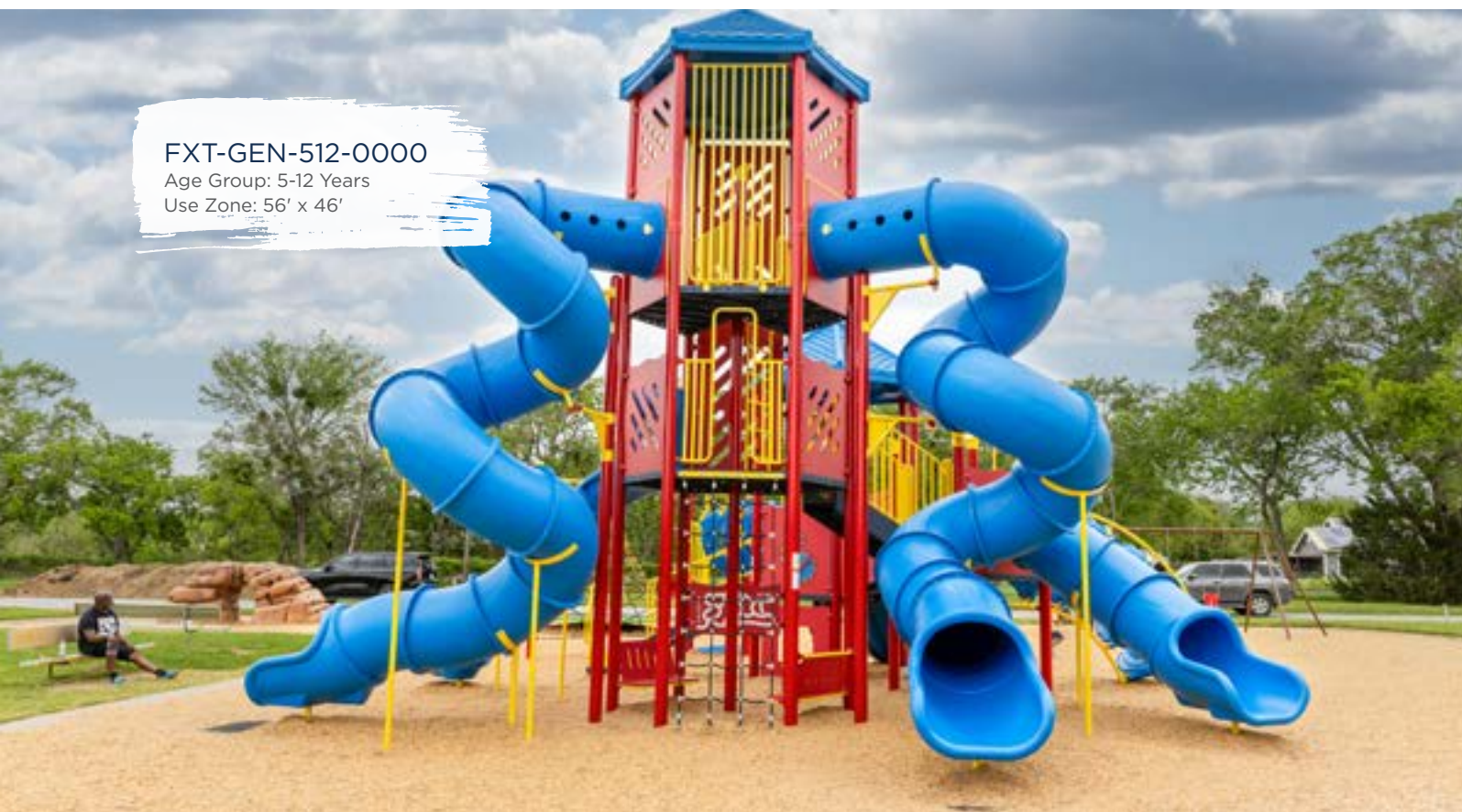

FXT-GEN-512-0000

Age Group: 5-12 Years
Use Zone: 56' x 46'

FXT-GEN-512-0003

Age Group: 5-12 Years
Use Zone: 62' x 57'



Reverse View

MODEL	AGES	CAPACITY	SIZE	USE ZONE	FALL HEIGHT	TOWER DECK HEIGHT	EST. TIMBER COUNT	ADA
FXT-GEN-512-0007	5-12	97	28' x 27'	40' x 38'	13'	13'	34	Yes
FXT-GEN-512-0000	5-12	82	41' x 33'	56' x 46'	14'	14'	46	Yes

MODEL	AGES	CAPACITY	SIZE	USE ZONE	FALL HEIGHT	TOWER DECK HEIGHT	EST. TIMBER COUNT	ADA
FXT-GEN-512-0034	5-12	87	47' x 41'	59' x 53'	14'	14'	55	Yes
FXT-GEN-512-0003	5-12	115	49' x 43'	62' x 57'	13'	13'	49	Yes



FXT-GEN-512-0011

Ages: 5-12 Years
Use Zone: 67' x 52'



FXT-GEN-512-0015

Ages: 5-12 Years
Use Zone: 71' x 66'



FXT-GEN-512-0025

Age Group: 5-12 Years
Use Zone: 37' x 30'



FXT-WIR-512-0012

Age Group: 5-12 Years
Use Zone: 58' x 34'



MODEL	AGES	CAPACITY	SIZE	USE ZONE	FALL HEIGHT	TOWER DECK HEIGHT	EST. TIMBER COUNT	ADA
FXT-GEN-512-0011	5-12	67	56' x 37'	67' x 52'	10'	10'	55	Yes
FXT-GEN-512-0025	5-12	62	25' x 18'	37' x 30'	10'	12'	29	Yes

MODEL	AGES	CAPACITY	SIZE	USE ZONE	FALL HEIGHT	TOWER DECK HEIGHT	EST. TIMBER COUNT	ADA
FXT-GEN-512-0015	5-12	148	59' x 57'	71' x 66'	14'	14'	77	Yes
FXT-WIR-512-0012	5-12	85	46' x 22'	58' x 34'	12'	12'	41	Yes



New! Kaiiju

Our new modular climbing system that expands play beyond the deck limits.

New! PS5-73070
Ages: 5-12 Years
Use Zone: 40' x 40'



New! FXT-KAI-512-0054
Age Group: 5-12 Years
Use Zone: 58' x 34'
Deck Height: 14'



MODEL	AGES	CAPACITY	SIZE	USE ZONE	FALL HEIGHT	EST. TIMBER COUNT	ADA
PS5-73070	5-12	36	28' x 28'	40' x 40'	7'	33	Yes
FXT-KAI-512-0054	5-12	100	43' x 40'	55' x 53'	14'	53	Yes

Warning! Installation over a hard surface such as concrete, asphalt, or packed earth may result in serious injury from falls.



Classic SERIES

These play structures include our budget-friendly 3.5" post system and 5" post system. Both have options for children ages 2-5, 2-12, and 5-12 years old.

5-12 Years



PS5-70851-2
 Age Group: 5-12 Years
 Use Zone: 54' x 58'



PS3-71844-2
 Ages: 5-12 Years
 Use Zone: 52' x 50'



New! **PS3-73103**
 Ages: 5-12 Years
 Use Zone: 70' x 45'



PS3-71392-1
 Age Group: 5-12 Years
 Use Zone: 47' x 42'
 Available Without Shade
PS3-71392-2

MODEL	AGES	CAPACITY	SIZE	USE ZONE	FALL HEIGHT	EST. TIMBER COUNT	ADA
PS5-70851-2	5-12	100-110	42' x 46'	54' x 58'	7'	48	Yes
PS3-73103	5-12	40-45	57' x 33'	70' x 45'	8'	50	Yes

MODEL	AGES	CAPACITY	SIZE	USE ZONE	FALL HEIGHT	EST. TIMBER COUNT	ADA
PS3-71844-2	5-12	69	40' x 38'	52' x 50'	6'	46	Yes
PS3-71392-1	5-12	55-60	35' x 30'	47' x 42'	7'	40	Yes

What's timber count? The amount of 4' playground timbers needed to surround the playground should a type of loose fill surfacing be used. See page 176 for more information.



5-12 Years

New! PS3-71712-1
Ages: 5-12 Years
Use Zone: 30' x 34'



New! PS3-31596
Ages: 5-12 Years
Use Zone: 30' x 46'



PS5-72546
Ages: 5-12 Years
Use Zone: 64' x 28'



PS3-72993
Ages: 5-12 Years
Use Zone: 32' x 42'

MODEL	AGES	CAPACITY	SIZE	USE ZONE	FALL HEIGHT	EST. TIMBER COUNT	ADA
PS3-71712-1	5-12	25-30	18' x 22'	30' x 34'	7'	32	Yes
PS5-72546	5-12	70-75	52' x 16'	64' x 28'	6'	41	Yes

MODEL	AGES	CAPACITY	SIZE	USE ZONE	FALL HEIGHT	EST. TIMBER COUNT	ADA
PS3-31596	5-12	35-40	18' x 34'	30' x 46'	7'	32	Yes
PS3-72993	5-12	40-45	20' x 30'	32' x 42'	7'	32	Yes

5-12 Years



New! PS3-73102
Ages: 5-12 Years
Use Zone: 62' x 34'



New! PS3-72559
Ages: 5-12 Years
Use Zone: 22' x 40'

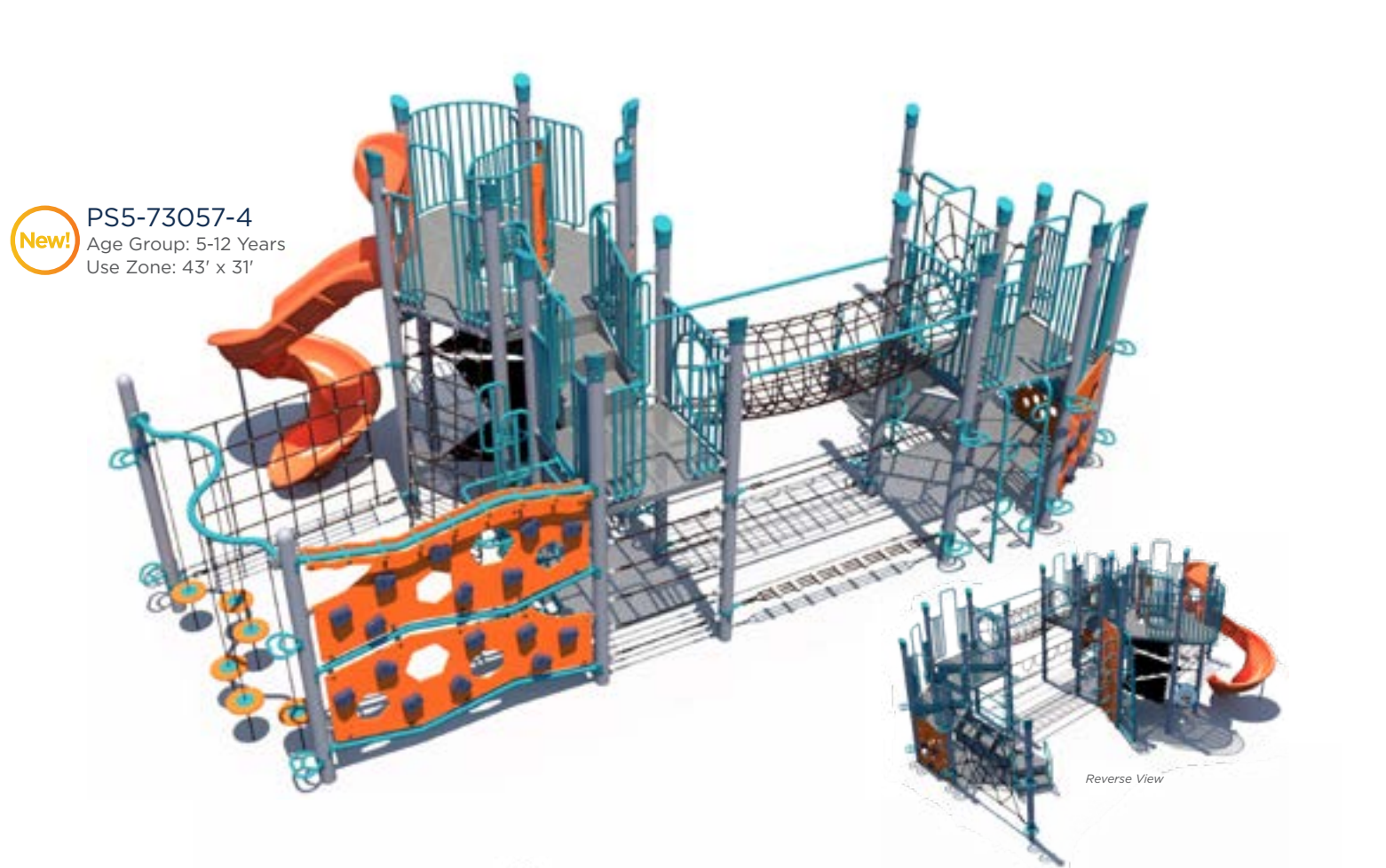

New! PS5-73057-4
Age Group: 5-12 Years
Use Zone: 43' x 31'

Reverse View



New! PS5-73160
Age Group: 5-12 Years
Use Zone: 54' x 32'
Available Without Shade
PS5-73160-1

Reverse View

MODEL	AGES	CAPACITY	SIZE	USE ZONE	FALL HEIGHT	EST. TIMBER COUNT	ADA
PS3-73102	5-12	45-50	50' x 22'	62' x 34'	8'	44	Yes
PS3-72559	5-12	35-40	10' x 28'	22' x 40'	6'	28	Yes

MODEL	AGES	CAPACITY	SIZE	USE ZONE	FALL HEIGHT	EST. TIMBER COUNT	ADA
PS5-73057-4	5-12	66	21' x 19'	43' x 31'	8'	33	No
PS5-73160	5-12	50-55	42' x 20'	54' x 32'	10'	42	Yes

5-12 Years

PS3-71784-1

Age Group: 5-12 Years
Use Zone: 55' x 42'

Available Without Shade
PS3-71784-2



Reverse View

PS5-73071

Age Group: 5-12 Years
Use Zone: 52' x 41'



Reverse View

New!

PS5-73088

Age Group: 5-12 Years
Use Zone: 50' x 57'



Reverse View

PS3-72372

Age Group: 5-12 Years
Use Zone: 33' x 35'



Reverse View

MODEL	AGES	CAPACITY	SIZE	USE ZONE	FALL HEIGHT	EST. TIMBER COUNT	ADA
PS3-71784-1	5-12	45-50	43' x 30'	55' x 42'	6'	42	Yes
PS5-73088	5-12	105-115	38' x 45'	50' x 57'	7'	51	Yes

MODEL	AGES	CAPACITY	SIZE	USE ZONE	FALL HEIGHT	EST. TIMBER COUNT	ADA
PS5-73071	5-12	110-120	40' x 29'	52' x 41'	8'	41	Yes
PS3-72372	5-12	20-25	21' x 23'	33' x 35'	7'	29	Yes

2-12 Years



PS3-71816
 Age Group: 2-12 Years
 Use Zone: 44' x 33'
 Available Without Shade
PS3-71816-1



PS3-71835
 Age Group: 2-12 Years
 Use Zone: 47' x 32'
 Available Without Shade
PS3-71835-1



New! **PS3-72624**
 Ages: 2-12 Years
 Use Zone: 30' x 31'



New! **PS5-71477**
 Ages: 2-12 Years
 Use Zone: 36' x 32'

MODEL	AGES	CAPACITY	SIZE	USE ZONE	FALL HEIGHT	EST. TIMBER COUNT	ADA
PS3-71816	2-12	40-45	32' x 21'	44' x 33'	5'	35	Yes
PS3-72624	2-12	15-20	18' x 19'	30' x 31'	6'	26	Yes

MODEL	AGES	CAPACITY	SIZE	USE ZONE	FALL HEIGHT	EST. TIMBER COUNT	ADA
PS3-71835	2-12	40-45	35' x 20'	35' x 20'	4'	35	Yes
PS5-71477	2-12	25-30	24' x 20'	36' x 32'	5'	30	Yes

2-12 Years



New!
PS3-70852
 Ages: 2-12 Years
 Use Zone: 31' x 31'



PS3-71313
 Age Group: 2-12 Years
 Use Zone: 39' x 23'



PS3-71067
 Ages: 2-12 Years
 Use Zone: 40' x 22'



PS5-72998
 Ages: 2-12 Years
 Use Zone: 49' x 37'

MODEL	AGES	CAPACITY	SIZE	USE ZONE	FALL HEIGHT	EST. TIMBER COUNT	ADA
PS3-70852	2-12	15-20	19' x 19'	31' x 31'	6'	28	Yes
PS3-71067	2-12	30-35	28' x 10'	40' x 22'	5'	32	Yes

MODEL	AGES	CAPACITY	SIZE	USE ZONE	FALL HEIGHT	EST. TIMBER COUNT	ADA
PS3-71313	2-12	20-25	27' x 11'	39' x 23'	6'	28	Yes
PS5-72998	2-12	75-80	37' x 25'	49' x 37'	5'	36	Yes

2-12 Years



PS3-31908
 Age Group: 2-12 Years
 Use Zone: 35' x 29'

Available
 With a 5" Post
PS5-31908

New!

PS3-73127
 Age Group: 2-12 Years
 Use Zone: 41' x 30'



Reverse View



PS3-70570
 Ages: 2-12 Years
 Use Zone: 39' x 29'

New!

PS5-73165
 Age Group: 2-12 Years
 Use Zone: 56' x 34'

Available Without Shade
PS5-73165-1



Reverse View

MODEL	AGES	CAPACITY	SIZE	USE ZONE	FALL HEIGHT	EST. TIMBER COUNT	ADA
PS3-31908	2-12	35-40	23' x 17'	35' x 29'	4'	32	Yes
PS3-70570	2-12	20-25	27' x 17'	39' x 29'	6'	28	Yes

MODEL	AGES	CAPACITY	SIZE	USE ZONE	FALL HEIGHT	EST. TIMBER COUNT	ADA
PS3-73127	2-12	35-40	29' x 18'	41' x 30'	6'	33	Yes
PS5-73165	2-12	60-65	44' x 22'	56' x 34'	5'	40	Yes

2-12 Years

PS3-72374

Age Group: 2-12 Years
Use Zone: 42' x 25'



PS3-72373

Age Group: 2-12 Years
Use Zone: 41' x 30'

Available Without Shade
PS3-72373-1



PS5-73095

Age Group: 2-12 Years
Use Zone: 43' x 35'



PS3-73034

Age Group: 2-12 Years
Use Zone: 49' x 34'



MODEL	AGES	CAPACITY	SIZE	USE ZONE	FALL HEIGHT	EST. TIMBER COUNT	ADA
PS3-72374	2-12	30-35	30' x 13'	42' x 25'	4'	30	Yes
PS5-73095	2-12	30-35	31' x 23'	43' x 35'	5'	32	Yes

MODEL	AGES	CAPACITY	SIZE	USE ZONE	FALL HEIGHT	EST. TIMBER COUNT	ADA
PS3-72373	2-12	30-35	29' x 18'	41' x 30'	4'	33	Yes
PS3-73034	2-12	65-70	37' x 22'	49' x 34'	6'	36	Yes

2-5 Years



PS5-73003
Ages: 2-5 Years
Use Zone: 57' x 35'



PS3-71158
Ages: 2-5 Years
Use Zone: 28' x 24'



New! **PS3-72028-3**
Age Group: 2-5 Years
Use Zone: 35' x 28'



PS3-72999
Ages: 2-5 Years
Use Zone: 29' x 28'
Available Without Shade
PS3-72999-1

MODEL	AGES	CAPACITY	SIZE	USE ZONE	FALL HEIGHT	EST. TIMBER COUNT	ADA
PS5-73003	2-5	50-55	45' x 23'	57' x 35'	4'	39	Yes
PS3-72028-3	2-5	45-50	23' x 16'	35' x 28'	3'	27	Yes

MODEL	AGES	CAPACITY	SIZE	USE ZONE	FALL HEIGHT	EST. TIMBER COUNT	ADA
PS3-71158	2-5	20-25	16' x 12'	28' x 24'	3'	22	Yes
PS3-72999	2-5	25-30	17' x 16'	29' x 28'	4'	23	Yes

2-5 Years



PS3-31385-1
Ages: 2-5 Years
Use Zone: 24' x 33'



PS3-71098-2
Age Group: 2-5 Years
Use Zone: 38' x 31'



PS3-31400-1
Ages: 2-5 Years
Use Zone: 28' x 36'



New! **PS3-72549**
Ages: 2-5 Years
Use Zone: 42' x 30'

MODEL	AGES	CAPACITY	SIZE	USE ZONE	FALL HEIGHT	EST. TIMBER COUNT	ADA
PS3-31385-1	2-5	30-35	12' x 21'	24' x 33'	4'	30	Yes
PS3-31400-1	2-5	25-30	16' x 24'	28' x 36'	5'	33	Yes

MODEL	AGES	CAPACITY	SIZE	USE ZONE	FALL HEIGHT	EST. TIMBER COUNT	ADA
PS3-71098-2	2-5	30-35	26' x 19'	38' x 31'	3'	30	Yes
PS3-72549	2-5	25-30	30' x 18'	42' x 30'	4'	33	Yes

2-5 Years



PS3-73017-1
Age Group: 2-5 Years
Use Zone: 38' x 21'



PS3-73099
Age Group: 2-5 Years
Use Zone: 33' x 28'



PS3-73009
Age Group: 2-5 Years
Use Zone: 30' x 34'

Available Without Shade
PS3-73009-1



PS3-72936-1
Age Group: 2-5 Years
Use Zone: 31' x 23'



MODEL	AGES	CAPACITY	SIZE	USE ZONE	FALL HEIGHT	EST. TIMBER COUNT	ADA
PS3-73017-1	2-5	30-35	26' x 09'	38' x 21'	3'	27	Yes
PS3-73009	2-5	35-40	18' x 22'	30' x 34'	3'	27	Yes

MODEL	AGES	CAPACITY	SIZE	USE ZONE	FALL HEIGHT	EST. TIMBER COUNT	ADA
PS3-73099	2-5	25-30	21' x 16'	33' x 28'	4'	28	Yes
PS3-72936-1	2-5	20-25	19' x 11'	31' x 23'	4'	24	Yes

Active Series



Active SERIES

This 5" steel post series keeps children active with its obstacle course-like activities.

New!

PA5-70728
Ages: 5-12 Years
Use Zone: 46' x 25'



New!

PA5-72175
Ages: 5-12 Years
Use Zone: 56' x 30'



MODEL	AGES	CAPACITY	SIZE	USE ZONE	FALL HEIGHT	EST. TIMBER COUNT
PA5-70728	5-12	20-25	24' x 13'	46' x 25'	8'	32
PS5-72175	5-12	20-25	44' x 18'	56' x 30'	7'	41

Warning! Installation over a hard surface such as concrete, asphalt, or packed earth may result in serious injury from falls.

Active Series

New!

PS5-73101
Age Group: 5-12 Years
Use Zone: 40' x 42'



PS5-71364
Age Group: 5-12 Years
Use Zone: 38' x 48'

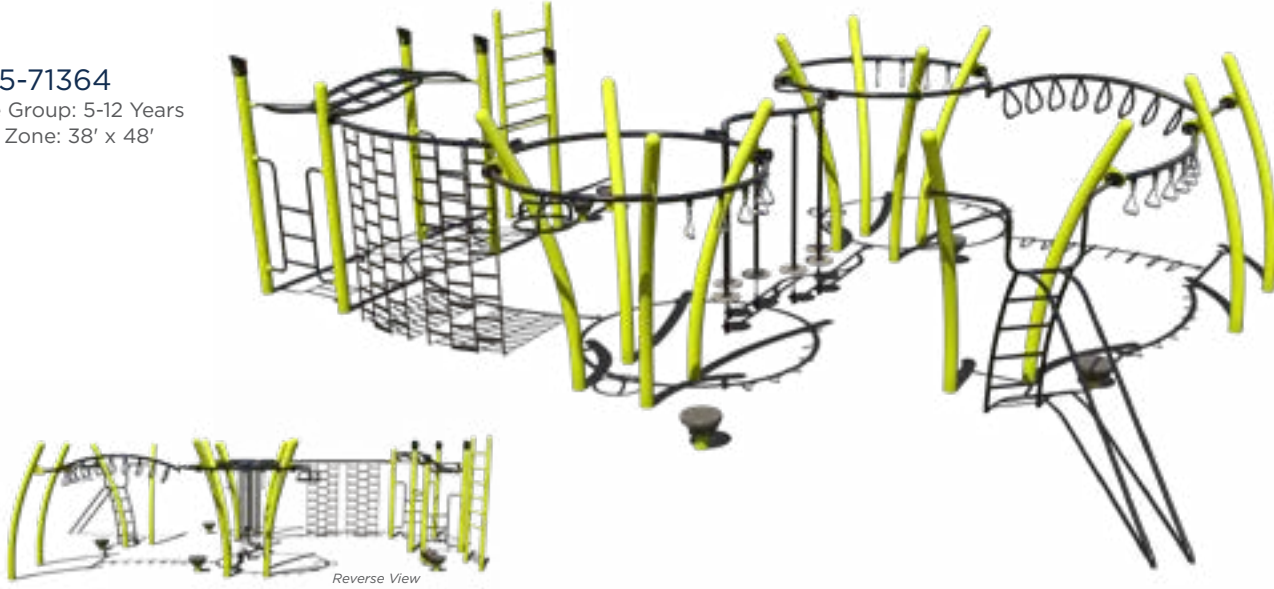

New!

PA5-72849
Age Group: 5-12 Years
Use Zone: 54' x 30'

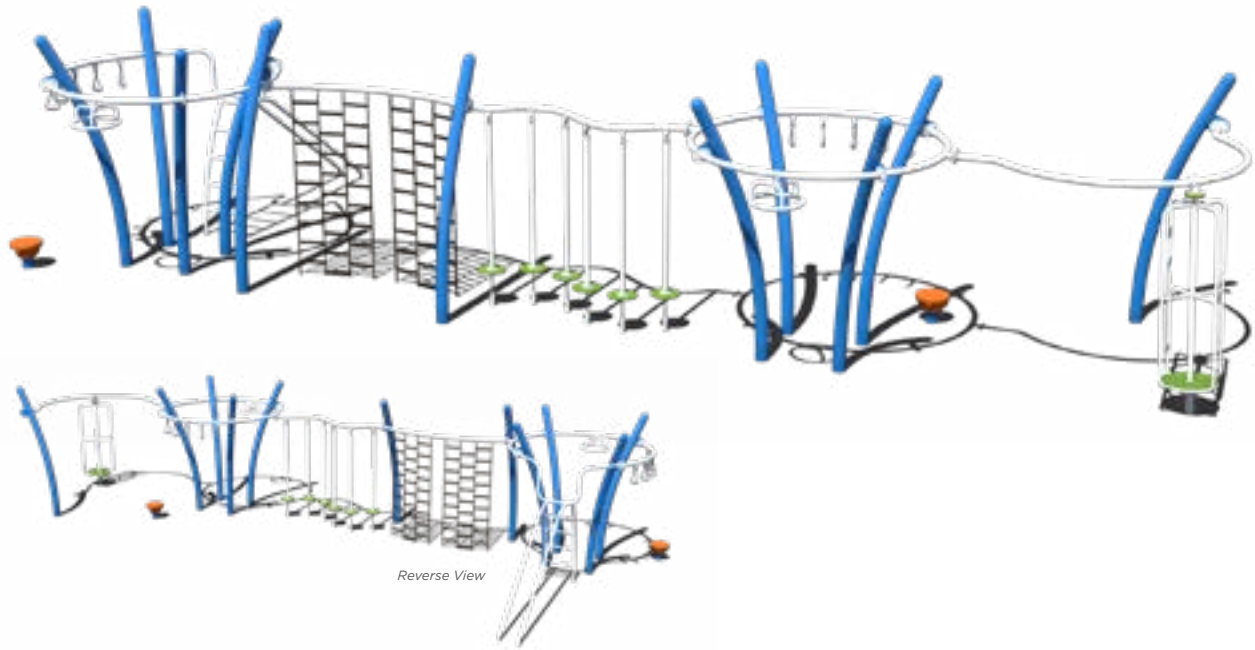

New!

PS5-72617
Age Group: 5-12 Years
Use Zone: 51' x 30'

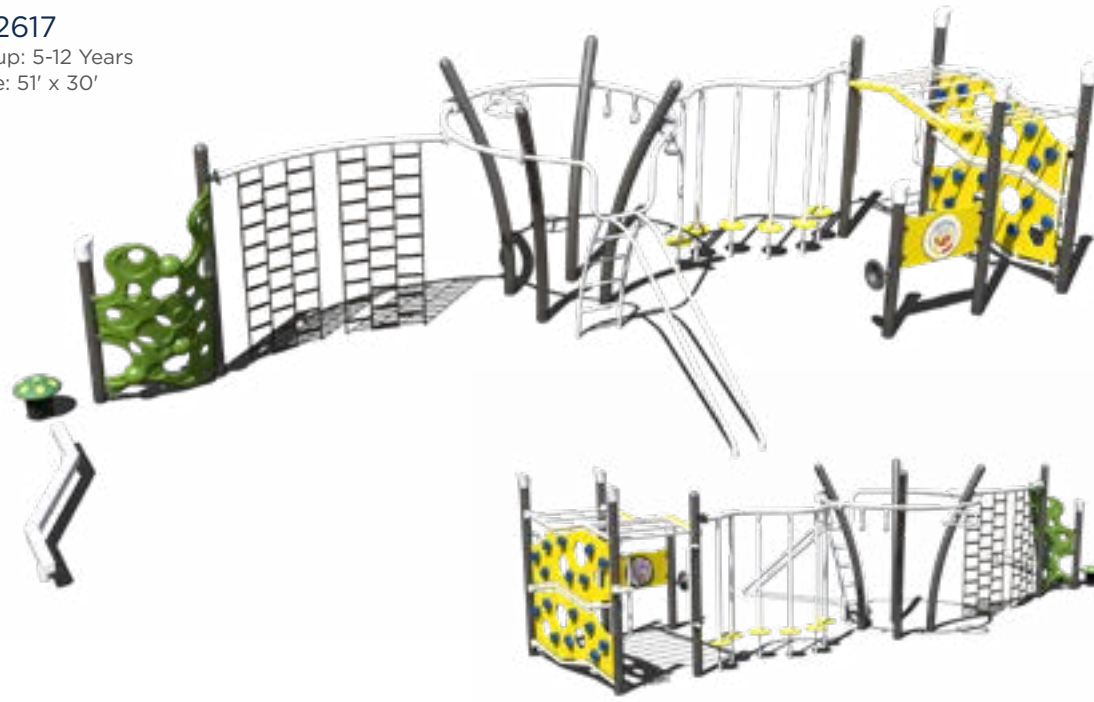

MODEL	AGES	CAPACITY	SIZE	USE ZONE	FALL HEIGHT	EST. TIMBER COUNT
PS5-73101	5-12	30-35	28' x 30'	40' x 42'	8'	26
PA5-72849	5-12	20-25	42' x 18'	54' x 30'	7'	41

MODEL	AGES	CAPACITY	SIZE	USE ZONE	FALL HEIGHT	EST. TIMBER COUNT
PS5-71364	5-12	25-30	26' x 36'	38' x 48'	7'	40
PS5-72617	5-12	20-25	39' x 18'	51' x 30'	7'	40

What's timber count? The amount of 4' playground timbers needed to surround the playground should a type of loose fill surfacing be used. See page 176 for more information.

Quick Ship

Choose from these six play structures in either the Terra or Spring Storm color scheme and your playground will ship within 5-8 business days, excluding holidays.

PS3-70693

Age Group: 2-5 Years
Use Zone: 32' x 22'



PS3-72329

Age Group: 5-12 Years
Use Zone: 36' x 31'



PS3-73077

Age Group: 2-5 Years
Use Zone: 28' x 27'



PS3-32207

Age Group: 5-12 Years
Use Zone: 30' x 30'



PS3-31905

Age Group: 2-12 Years
Use Zone: 30' x 30'



PS3-72338

Age Group: 5-12 Years
Use Zone: 37' x 32'



MODEL	AGES	CAPACITY	SIZE	USE ZONE	FALL HEIGHT	EST. TIMBER COUNT	ADA
PS3-70693	2-5	20-25	20' x 10'	32' x 22'	3'	22	Yes
PS3-72216	2-5	15-20	16' x 15'	28' x 27'	3'	25	Yes
PS3-31905	2-12	20-25	18' x 18'	30' x 30'	5'	25	Yes

MODEL	AGES	CAPACITY	SIZE	USE ZONE	FALL HEIGHT	EST. TIMBER COUNT	ADA
PS3-72329	5-12	25-30	24' x 19'	36' x 31'	6'	28	Yes
PS3-32207	5-12	15-20	18' x 18'	30' x 30'	7'	26	Yes
PS3-72338	5-12	35-40	25' x 20'	37' x 32'	7'	31	Yes



Early Childhood

- 108 Steel Structures
- 110 Adventures in Growing®
- 111 Tot-Trek®
- 112 Discovery Centers®

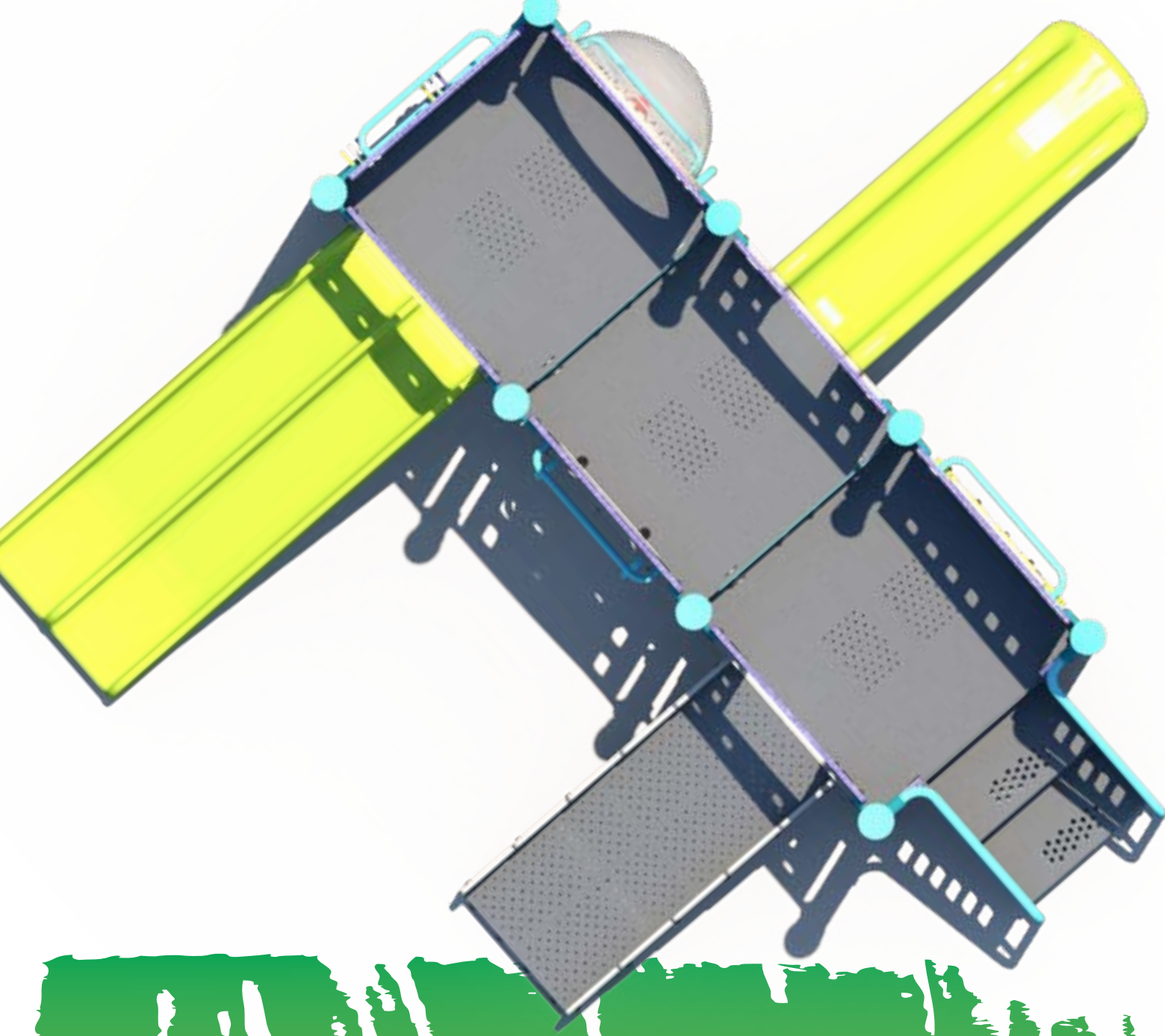

New!

6-23 Month Structures

Our new play structures are designed with age-appropriate activities for children ages 6-23 months.

New!

TTL-0001XX
Age Group: 6-23 Months
Use Zone: 15' x 08'

Available With Shade
TTL-0021XX



New!

TTL-0022XX
Age Group: 6-23 Months
Use Zone: 17' x 13'

Available Without Shade
TTL-0002XX



New!

TTL-0003XX
Age Group: 6-23 Months
Use Zone: 18' x 16'

Available With Shade
TTL-0023XX



MODEL	AGES	CAPACITY	SIZE	USE ZONE	FALL HEIGHT	ACTIVITIES	EST. TIMBER COUNT
TTL-0001XX	6-23 Mo.	12	10' x 04'	15' x 08'	24"	5	10
TTL-0002XX	6-23 Mo.	17	12' x 09'	17' x 13'	24"	7	13
TTL-0003XX	6-23 Mo.	24	13' x 13'	18' x 16'	30"	10	15

What's timber count? The amount of 4' playground timbers needed to surround the playground should a type of loose fill surfacing be used. See page 176 for more information.

Adventures in Growing®



Tot-Trek®



AIG012

Age Group: 6-23 Months
Capacity: 7
Structure Size: 11' x 2 1/2'
Use Zone: 24' x 15'
Includes:
• Slide
• Bongos
• Finger Maze
• Stairs



TFR0520XX

Age Group: 6-23 Months
Capacity: 5
Structure Size: 8' x 6'
Includes:
• Stairs
• Slide
• Bubble Window
• Texture Panel
• Climber



AIG021

Age Group: 6-23 Months
Capacity: 8
Structure Size: 11' x 6'
Use Zone: 24' x 19'
Includes:
• Slide
• Bongos
• Shape Spinners
• Stairs
• Sound Cylinder and Bead Panel
• Arch Climber



TFR0533XX

Age Group: 6-23 Months
Capacity: 10
Structure Size: 12' x 8'
Includes:
• Phase One
• Bridge
• Climber
• Stairs
• Activity Panels



AIG031

Age Group: 6-23 Months
Capacity: 9
Structure Size: 11' x 8 1/2'
Use Zone: 24' x 21'
Includes:
• Slide
• Bongos
• Spin and Find
• Stairs
• Texture Panel
• Texture Climber



TFR0518XX

Age Group: 6-23 Months
Capacity: 15
Structure Size: 14' x 15'
Includes:
• Phase Two
• Crawl Tube
• Slide
• Activity Panels



New! New Springtime Color Scheme

Discovery Centers®

These units offer standards-based developmental and educational activities. They are easy to assemble and come with a 10-year limited warranty on upright posts and a 5-year limited warranty on plastic. Colors are shown. Mounting options available are ground spike or anchor bolt. Inquire about part numbers for each.

Discovery Center 2

Structure: Inquire for part number
Age Group: 2-5 Years
Use Zone: 22' x 27'

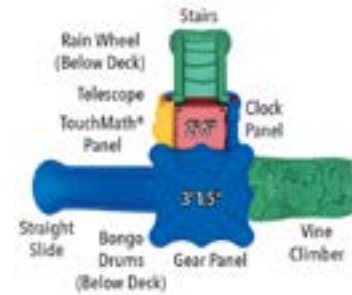

Discovery Center 4

Structure: Inquire for part number
Age Group: 2-5 Years
Use Zone: 27' x 28'

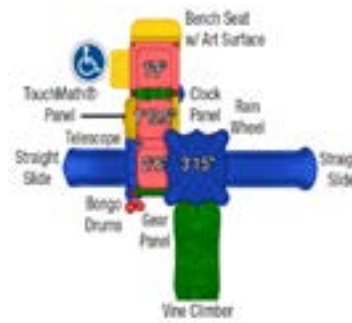

Discovery Center 5

Structure: Inquire for part number
Age Group: 2-5 Years
Use Zone: 28' x 31'

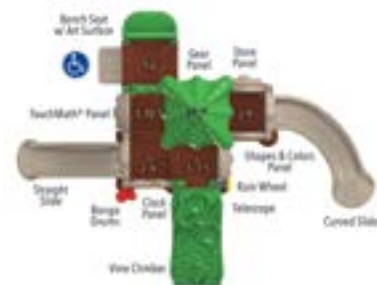

Seedling

Structure: Inquire for part number
Age Group: 6-23 Months
Use Zone: 13' 7" x 13' 5"



Super Sprout

Structure: Inquire for part number
Age Group: 6-23 Months
Use Zone: 14' 2" x 10' 5"
Meets ASTM F1487 Standards



Sapling

Structure: Inquire for part number
Age Group: 6-23 Months
Use Zone: 14' 5" x 19' 6"

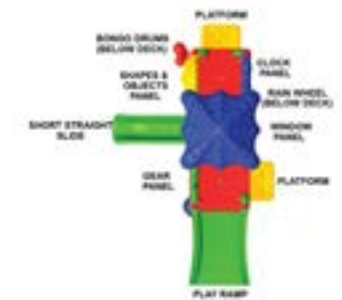

MODEL	AGES	CAPACITY	USE ZONE	FALL HEIGHT	MOUNTING
Discovery Center 2	2-5	10-15	22' x 27'	3' 1.5"	Ground Spike or Anchor Bolt
Discovery Center 4	2-5	15-20	27' x 28'	3' 1.5"	Ground Spike or Anchor Bolt
Discovery Center 5	2-5	20-25	28' x 31'	3' 9"	Ground Spike or Anchor Bolt

MODEL	AGES	CAPACITY	USE ZONE	FALL HEIGHT	MOUNTING
Seedling	6-23 Months	8-10	13' 7" x 13' 5"	1' 10"	Ground Spike or Anchor Bolt
Super Sprout	6-23 Months	6-8	14' 2" x 10' 5"	1' 3"	Ground Spike or Anchor Bolt
Sapling	6-23 Months	15-25	14' 5" x 19' 6"	1' 10"	Ground Spike or Anchor Bolt



Freestanding Play

- 116 Climbers
- 135 SISTEM
- 136 Overhead Ladders
- 137 Slides
- 138 Motion
- 142 Swings & Zip Line
- 145 Games
- 146 Nature Play
- 148 Musical Play
- 150 Dramatic Play

Ascend Rope Climbers

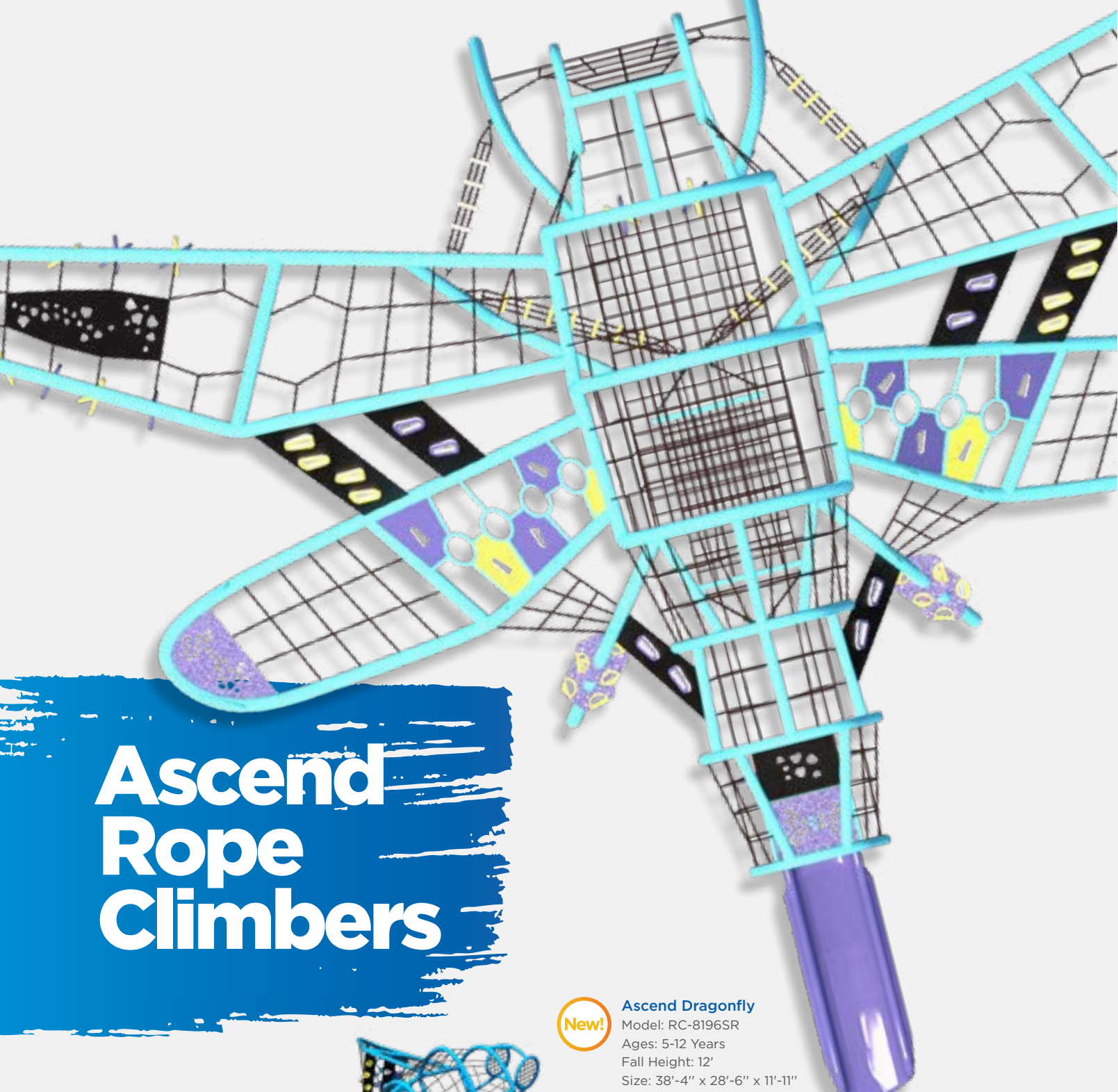

New! **Ascend Dragonfly**
Model: RC-8196SR
Ages: 5-12 Years
Fall Height: 12'
Size: 38'-4" x 28'-6" x 11'-11"
Use Zone: 50'-4" x 40'-6"



New! **Ascend Manta Ray**
Model: RC-8081SR
Ages: 5-12 Years
Fall Height: 9'
Size: 46'-5" x 40'-10" x 8'-3"
Use Zone: 58'-5" x 52'-10"

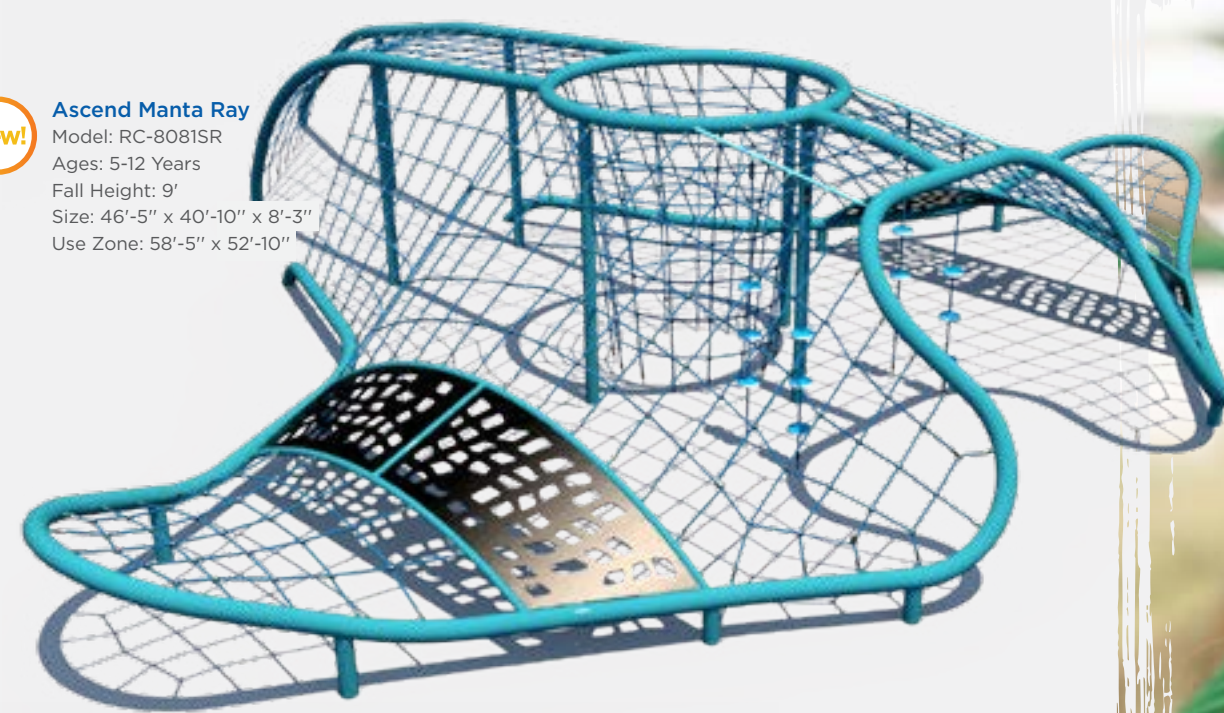

Ascend Orbiter
Model: RC-923SR
Use Zone: 37' 9" x 36' 11"
Fall Height: 10'
Ages: 5-12



New! **Ascend Swirl Twist**
Model: RC-R007SR
Ages: 5-12 Years
Fall Height: 9'
Size: 19'-8" x 19'-9" x 9'-2"
Use Zone: 31'-8" x 31'-9"

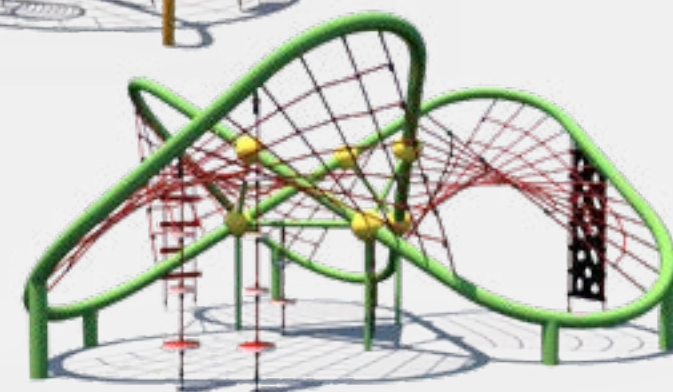

Ascend Mosura
Model: RC-8150SR
Use Zone: 34' 11" x 33' 10"
Capacity: 40
Fall Height: 9'
Ages: 5-12



Climbers

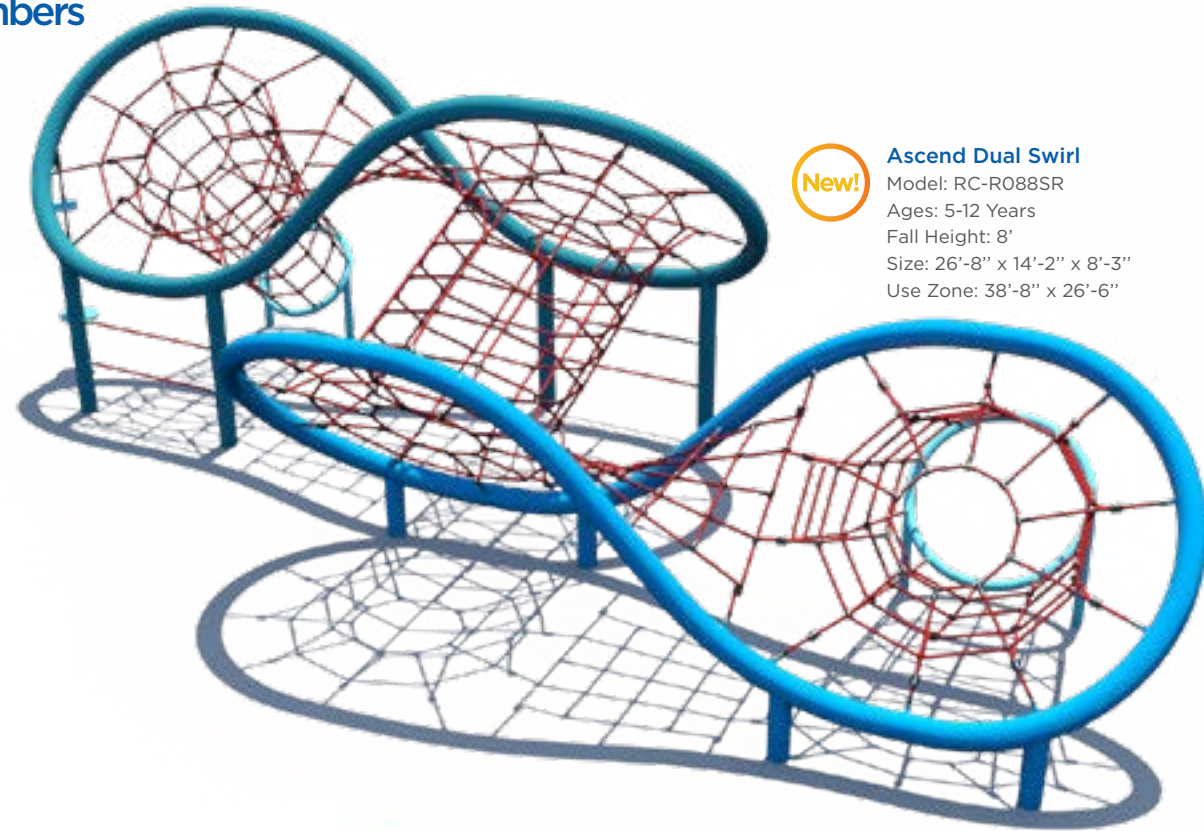

New! **Ascend Dual Swirl**
 Model: RC-R088SR
 Ages: 5-12 Years
 Fall Height: 8'
 Size: 26'-8" x 14'-2" x 8'-3"
 Use Zone: 38'-8" x 26'-6"

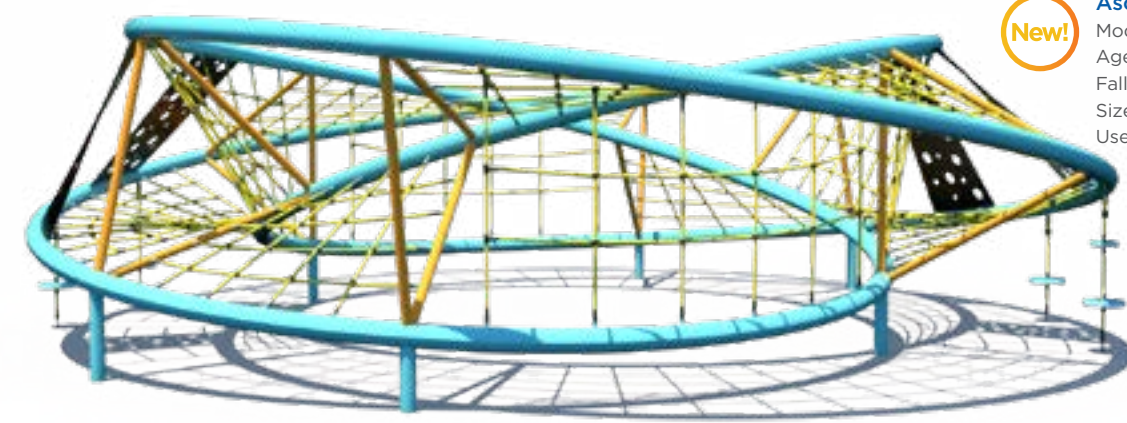

New! **Ascend Dual Cyclone**
 Model: RC-R005SR
 Ages: 5-12 Years
 Fall Height: 7'
 Size: 26'-1" x 23'-5" x 7'-4"
 Use Zone: 38'-1" x 35'-5"

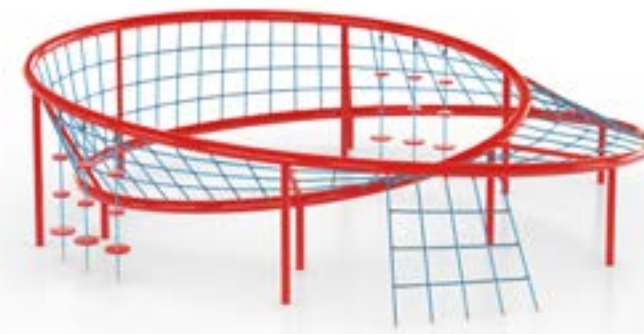

New! **Ascend Cyclone Twist**
 Model: RC-R004SR
 Ages: 5-12 Years
 Fall Height: 6'
 Size: 23'-11" x 23'-6" x 6'-5"
 Use Zone: 35'-11" x 35'-6"



New! **Ascend Cyclone**
 Model: RC-8064SR
 Ages: 5-12 Years
 Fall Height: 9'
 Size: 22'-3" x 22'-3" x 8'-9"
 Use Zone: 34'-3" x 34'-3"

New! **Ascend Swirl**
 Model: RC-R008SR
 Ages: 5-12 Years
 Fall Height: 5'
 Size: 17'-1" x 8' x 5'-11"
 Use Zone: 29'-1" x 20'



New! **Ascend Wave Track**
 Model: RC-8186SR
 Ages: 5-12 Years
 Fall Height: 8'
 Size: 30'-8" x 25'-10" x 7'-10"
 Use Zone: 42'-8" x 37'-10"



New! **Ascend Loop**
 Model: RC-8187SR
 Ages: 5-12 Years
 Fall Height: 10'
 Size: 29'-4" x 25'-5" x 10'-7"
 Use Zone: 41'-5" x 37'-5"



New! **Ascend Starpad**
 Model: RC-R009SR
 Ages: 5-12 Years
 Fall Height: 5'
 Size: 24'-2" x 21'-6" x 9'-1"
 Use Zone: 36' x 33'-6"

Climbers

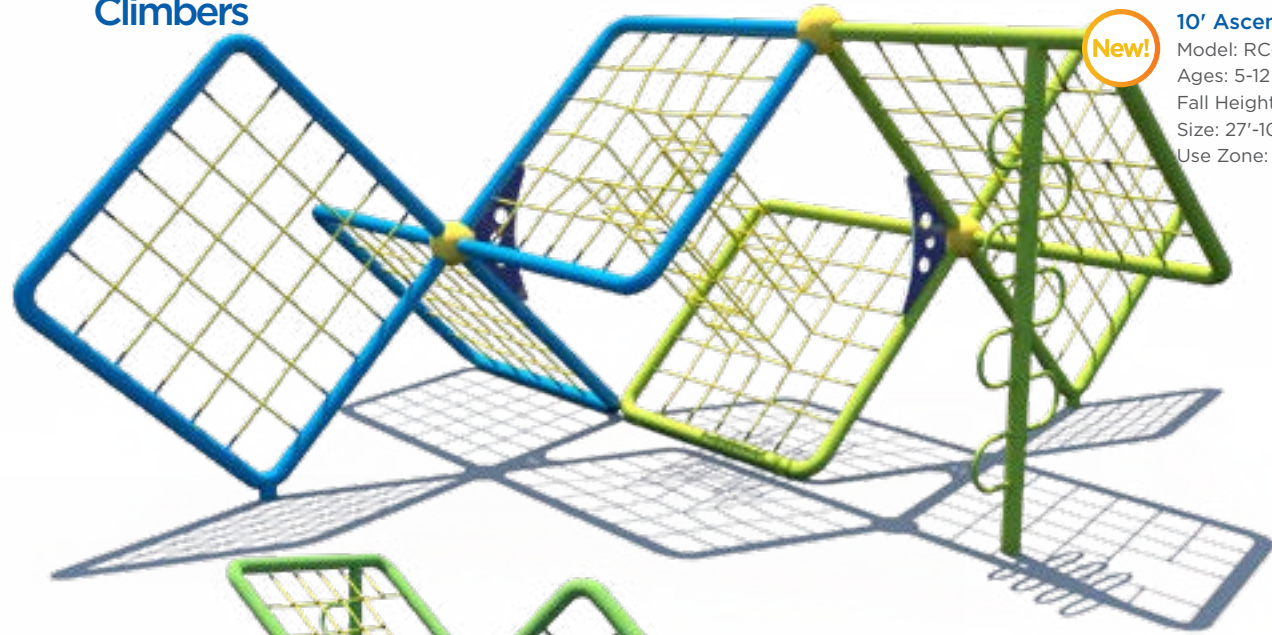

New! 10' Ascend Origami
 Model: RC-F201SR
 Ages: 5-12 Years
 Fall Height: 10'
 Size: 27'-10" x 20'-1" x 10'
 Use Zone: 39'-10" x 32'-1"

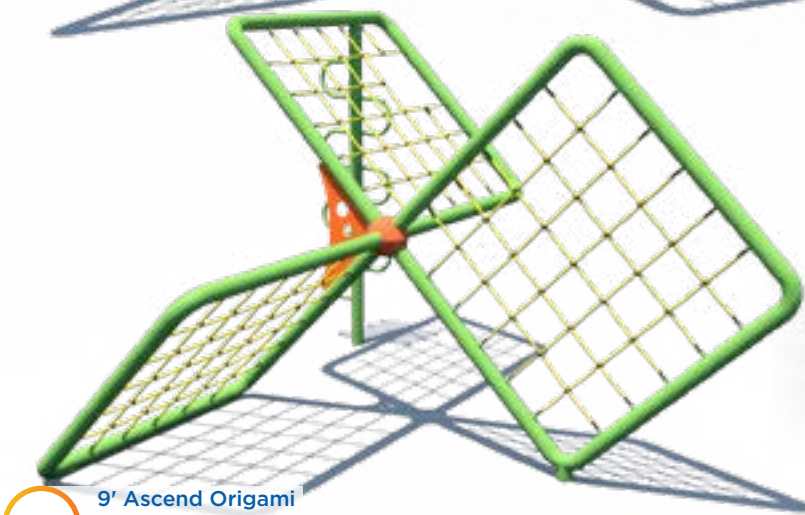

New! 9' Ascend Origami
 Model: RC-F101SR
 Ages: 5-12 Years
 Fall Height: 9'
 Size: 15'-2" x 13'-6" x 9'-6"
 Use Zone: 27'-2" x 25'-6"



New! 7' Ascend Origami
 Model: RC-F8188SR
 Ages: 5-12 Years
 Fall Height: 7'
 Size: 10'-8" x 9'-1" x 6'-5"
 Use Zone: 22'-8" x 21'-1"



New! Ascend Modern 10
 Model: RC-8097SR
 Ages: 5-12 Years
 Fall Height: 10'
 Size: 30'-7" x 11'-1" x 10'-3"
 Use Zone: 42'-8" x 23'



New! Ascend Modern 11
 Model: RC-8098SR
 Ages: 5-12 Years
 Fall Height: 11'
 Size: 40'-11" x 13' x 12'
 Use Zone: 53'-5" x 25'-2"



New! Ascend Soar with Slide
 Model: RC-813SR
 Ages: 5-12 Years
 Fall Height: 6'
 Size: 26' x 14'-7" x 12'
 Use Zone: 38' x 26'7"



New! Ascend Airplane
 Model: RC-P101SR
 Ages: 5-12 Years
 Fall Height: 7'
 Size: 27'-1" x 22'-9" x 6'-11"
 Use Zone: 39'-1" x 34'-9"

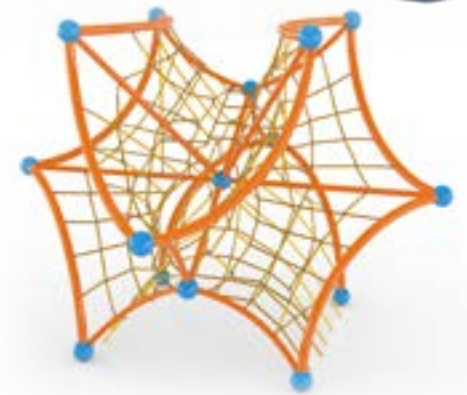

New! Ascend Soar
 Model: RC-811SR
 Ages: 5-12 Years
 Fall Height: 10'
 Size: 10'-6" x 10'-6" x 10'-6"
 Use Zone: 22'-6" x 22'-6"

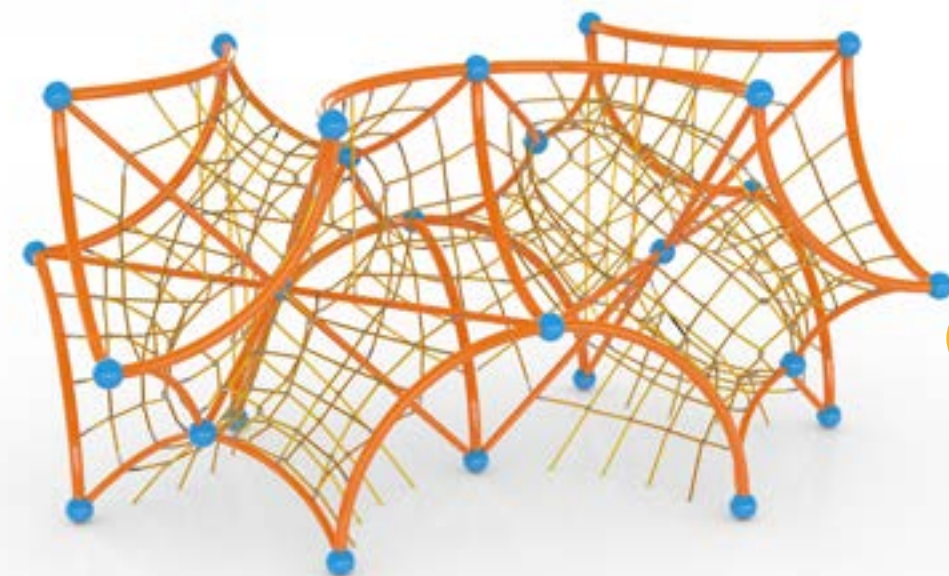

New! Ascend Soar Duo
 Model: RC-812SR
 Ages: 5-12 Years
 Fall Height: 10'
 Size: 20'-5" x 10'-6" x 10'-6"
 Use Zone: 32'-5" x 22'-6"

Climbers



13' Ascend Tower

Ascend Tower
Ages: 5-12

11' Tower
Model: RC-101-1SR
Use Zone: 27' 6" x 27' 6"
Fall Height: 6'

13' Tower (shown)
Model: RC-101SR
Use Zone: 30' 7" x 30' 7"
Fall Height: 6'

15' Tower
Model: RC-102-1SR
Use Zone: 37' 6" x 37' 6"
Fall Height: 7'

19' Tower
Model: RC-102SR
Use Zone: 44' 6" x 44' 6"
Fall Height: 7'

25' Tower
Model: RC-103SR
Use Zone: 52' 2" x 52' 2"
Fall Height: 7'

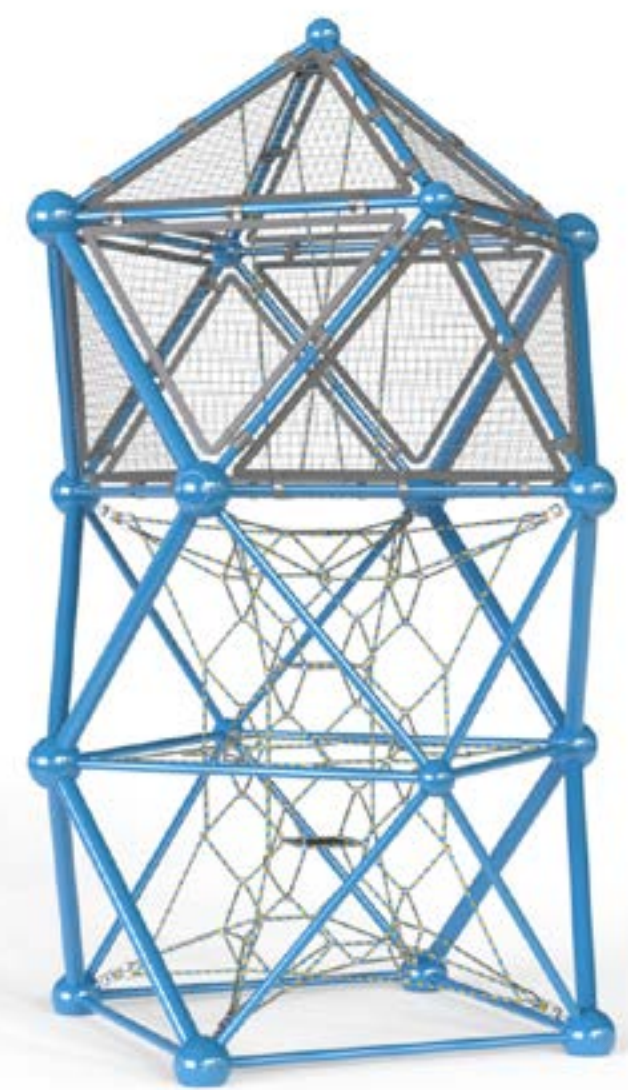

Ascend Thrill Tower
Model: RC-X2SR
Use Zone: 23' 3" x 22' 11"
Fall Height: 10'
Ages: 5-12

Thrill Tower with Slide Also Available
RC-X2SITSR

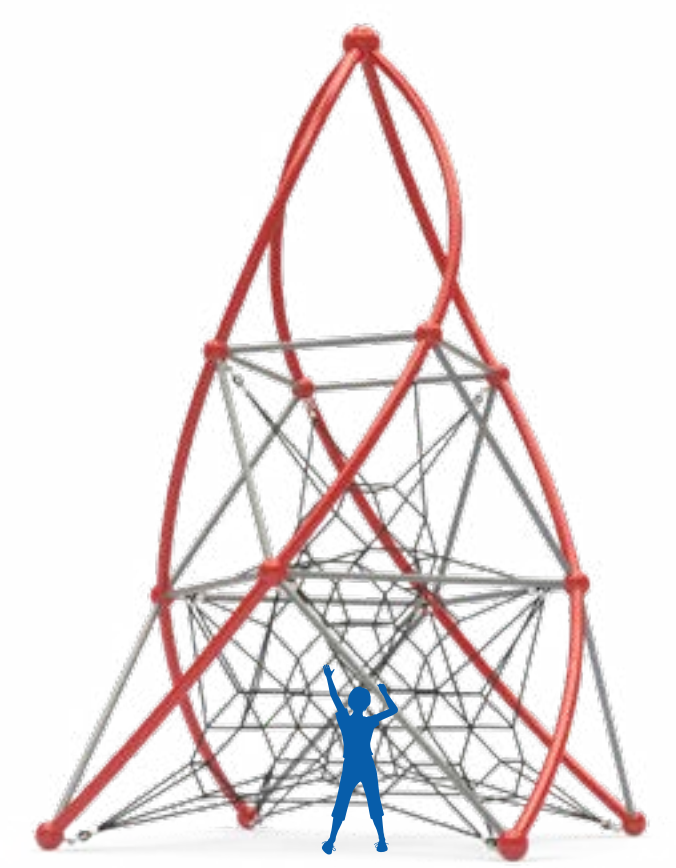

Ascend Thrill Swirl Tower
Model: RC-1701-SR
Use Zone: 24' x 24'
Fall Height: 9'
Ages: 5-12

Swirl Thrill Tower with Slide Also Available
RC-1702T-SR

Ascend Spire
Model: RC-8075
Use Zone: 29' x 36'
Fall Height: 14'
Ages: 5-12

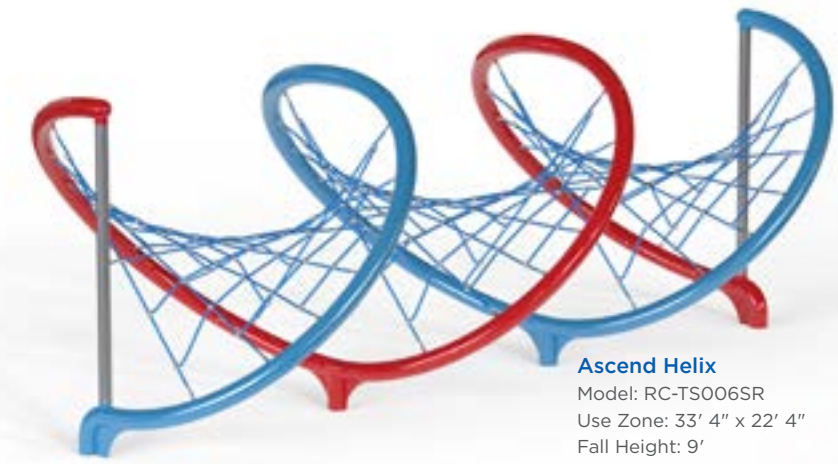

Ascend Helix
Model: RC-TS006SR
Use Zone: 33' 4" x 22' 4"
Fall Height: 9'
Ages: 5-12



9' Ascend Conquer
Model: RC-SM02SR
Use Zone: 26' 4" x 26' 4"
Fall Height: 5'
Ages: 5-12

10' Ascend Conquer
Model: RC-SM01SR
Use Zone: 26' 2" x 24' 4"
Fall Height: 6'
Ages: 5-12

10' Ascend Conquer Max
Model: RC-SM03SR
Use Zone: 32' 10" x 32' 10"
Fall Height: 5'
Ages: 5-12

Climbers

Ascend Atom
 Model: RC-903SR
 Use Zone: 26' 4" x 24' 9"
 Fall Height: 7'
 Ages: 5-12



15' Ascend Peak Max
 Model: RC-804SR
 Use Zone: 31' 3" x 31' 3"
 Fall Height: 8'
 Ages: 5-12

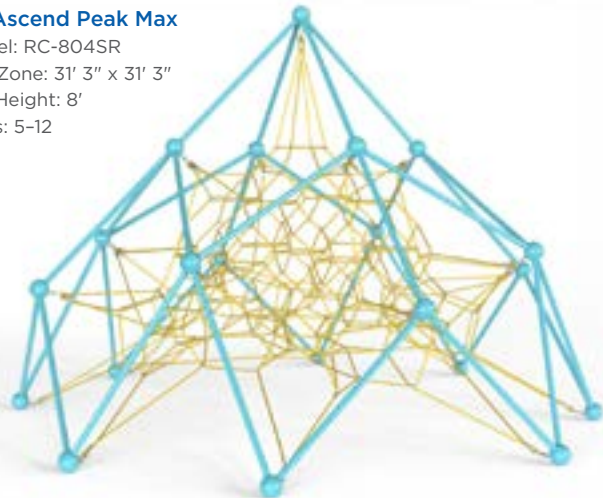

Ascend Demi Helix
 Model: RC-TS001SR
 Use Zone: 26' 5" x 22' 4"
 Fall Height: 9'
 Ages: 5-12

Ascend Top Spinner
 Model: RC-2300-F-SR
 Use Zone: 22' 10" x 22' 10"
 Fall Height: 8'
 Ages: 5-12



14' Ascend Web Whirl
 Model: RC-2100-FSR
 Use Zone: 22' 10" x 22' 10"
 Fall Height: 10'
 Ages: 5-12



Ascend Arch
 Model: RC-909SR
 Use Zone: 25' 6" x 25' 6"
 Fall Height: 6'
 Ages: 5-12

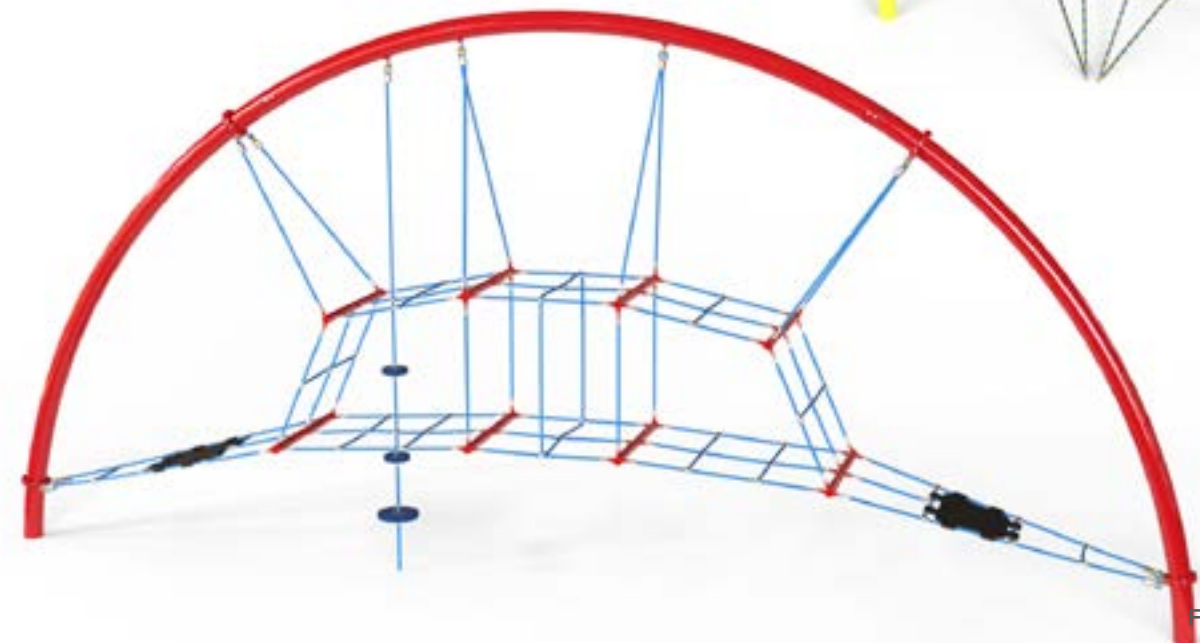

Ascend Gateway
 Model: RC-9001SR
 Use Zone: 38' 9" x 15' 2"
 Fall Height: 7'
 Ages: 5-12

Climbers



Ascend Funnel Web
 Model: RC-L005-SR
 Use Zone: 73' x 70' 5"
 Fall Height: 9'
 Ages: 5-12



Ascend Treefort with Tower
 Model: RC-8039SR
 Use Zone: 39' 3" x 35' 6"
 Fall Height: 10'
 Ages: 5-12

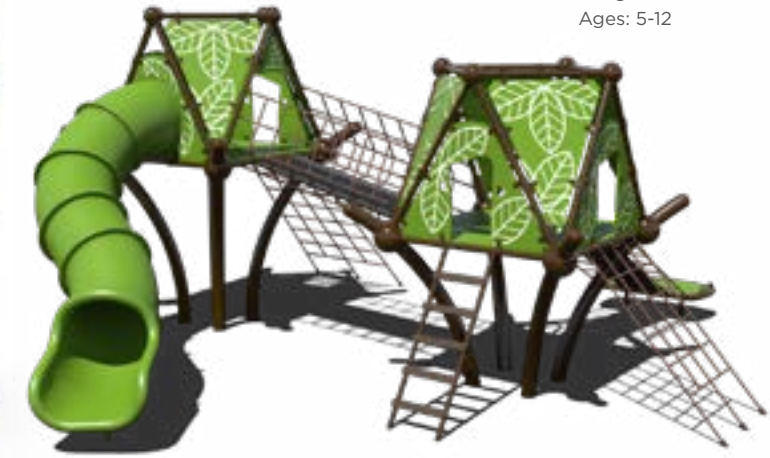

Ascend Dual Treefort
 Model: RC-NTS2001
 Use Zone: 38' 11" x 36' 10"
 Fall Height: 7'
 Ages: 5-12



Ascend Tall Loop Track
 Model: RC-R003SR
 Use Zone: 40' 10" x 40' 10"
 Fall Height: 8'
 Ages: 5-12



Ascend Low Wave Track
 Model: RC-M006SR
 Use Zone: 41' 10" x 35' 1"
 Fall Height: 5'
 Ages: 5-12



Ascend Low Loop Track
 Model: RC-M001-1SR
 Use Zone: 31' 3" x 28' 1"
 Fall Height: 5'
 Ages: 5-12



Ascend Tall Wave Track
 Model: RC-R001SR
 Use Zone: 53' 1" x 40' 10"
 Fall Height: 7'
 Ages: 5-12



Ascend Treefort
 Model: RC-NTS1002
 Use Zone: 34' x 30' 6"
 Fall Height: 7'
 Ages: 5-12



Ascend Overlook with Slide
 Model: RC-SH102T-SR
 Fall Height: 5'
 Use Zone: 38' 6" x 31' 2"
 Ages: 5-12

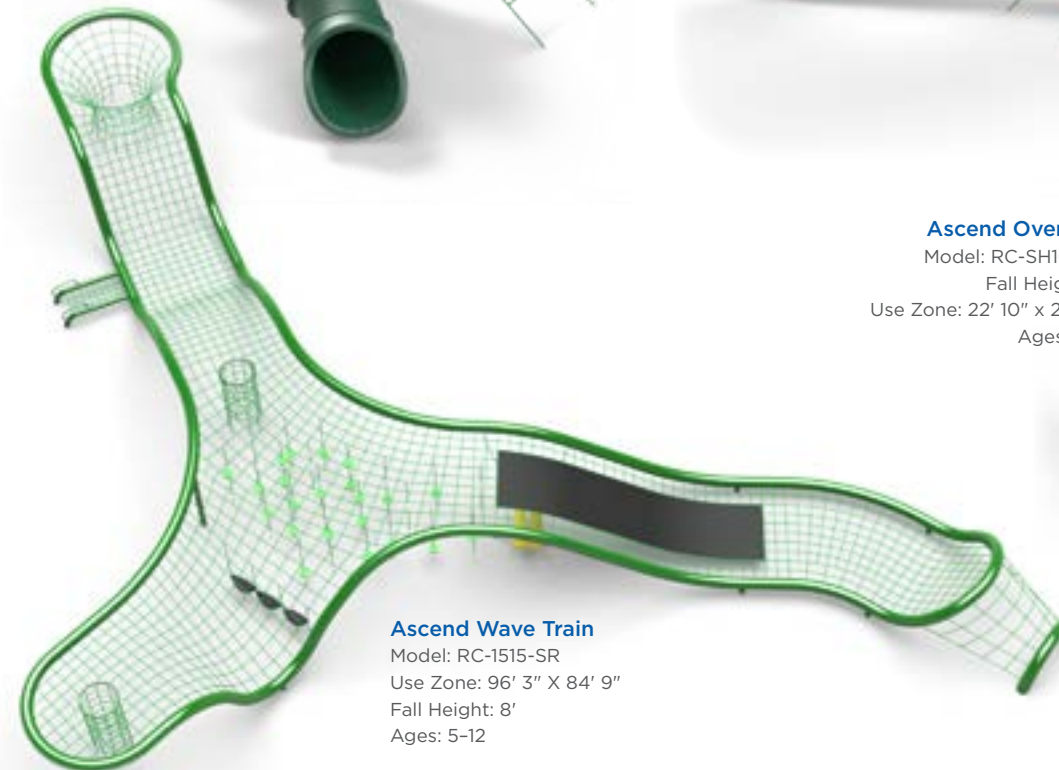

Ascend Wave Train
 Model: RC-1515-SR
 Use Zone: 96' 3" X 84' 9"
 Fall Height: 8'
 Ages: 5-12



Ascend Overlook
 Model: RC-SH101-SR
 Fall Height: 5'
 Use Zone: 22' 10" x 22' 10"
 Ages: 5-12

HelioNet

HelioNet

Model: HLN-6000
Use Zone: 28' x 27'
Fall Height: 8'
Ages: 5-12

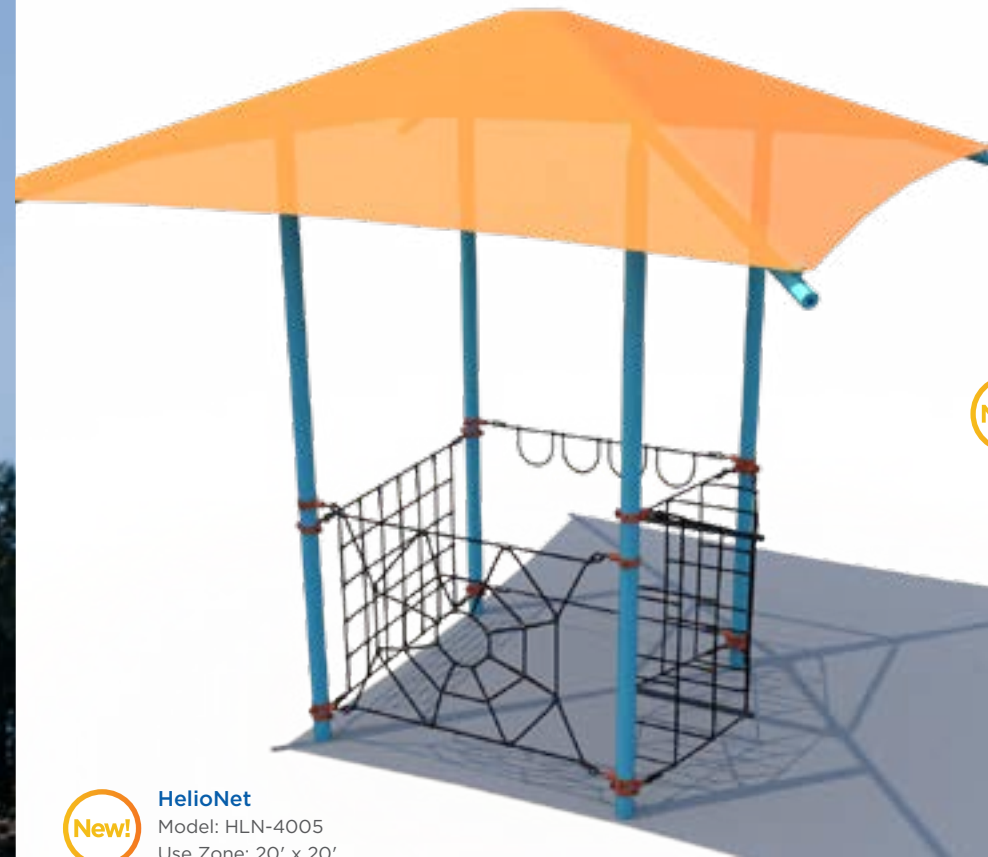

New! HelioNet
Model: HLN-4005
Use Zone: 20' x 20'
Fall Height: 7'
Ages: 5-12



New! HelioNet
Model: HLN-4004
Use Zone: 20' x 20'
Fall Height: 7'
Ages: 5-12



HelioNet
Model: HLN-6001
Use Zone: 28' x 26'
Fall Height: 8'
Ages: 5-12



New! HelioNet
Model: HLN-4008
Use Zone: 20' x 20'
Fall Height: 7'
Ages: 5-12



New! HelioNet
Model: HLN-4009
Use Zone: 20' x 20'
Fall Height: 7'
Ages: 5-12

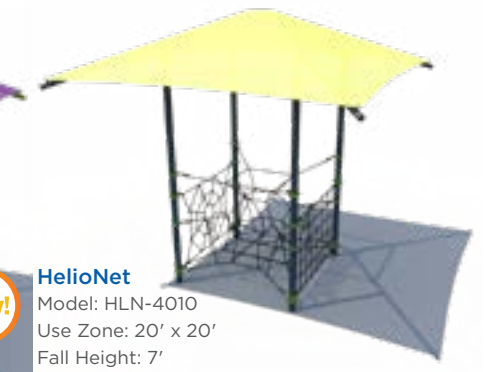

New! HelioNet
Model: HLN-4010
Use Zone: 20' x 20'
Fall Height: 7'
Ages: 5-12



New! HelioNet
Model: HLN-6003
Use Zone: 28' x 26'
Fall Height: 8'
Ages: 5-12



New! HelioNet
Model: HLN-6006
Use Zone: 28' x 26'
Fall Height: 8'
Ages: 5-12



New! HelioNet
Model: HLN-6007
Use Zone: 28' x 26'
Fall Height: 8'
Ages: 5-12



New! HelioNet
Model: HLN-4011
Use Zone: 20' x 20'
Fall Height: 7'
Ages: 5-12



New! HelioNet
Model: HLN-4012
Use Zone: 20' x 20'
Fall Height: 7'
Ages: 5-12



New! HelioNet
Model: HLN-6008
Use Zone: 20' x 20'
Fall Height: 7'
Ages: 5-12

View alternate views at
srpplayground.com/products/rope-play

Climbers

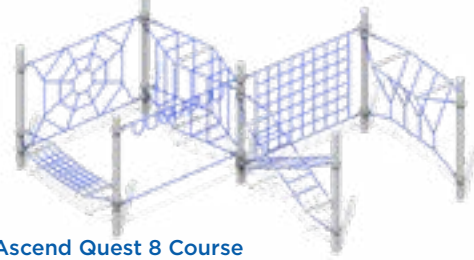

Ascend Quest 8 Course
 Model: RC-A008SR
 Use Zone: 34' 7" x 32' 8"
 Fall Height: 7'
 Ages: 5-12

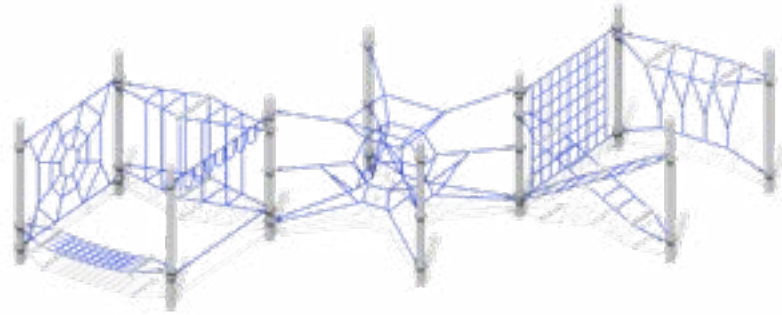

Ascend Quest 9 Course
 Model: RC-A009SR
 Use Zone: 44' 5" x 42' 3"
 Fall Height: 7'
 Ages: 5-12

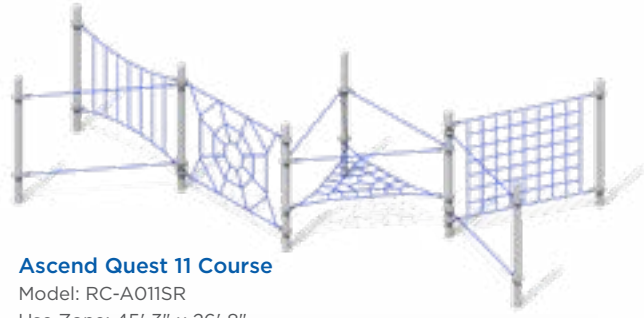

Ascend Quest 11 Course
 Model: RC-A011SR
 Use Zone: 45' 3" x 26' 8"
 Fall Height: 7'
 Ages: 5-12

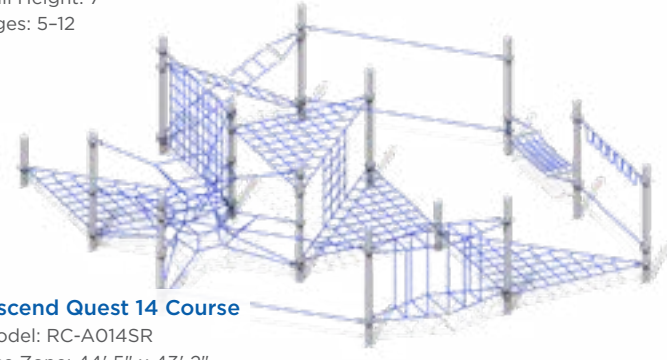

Ascend Quest 14 Course
 Model: RC-A014SR
 Use Zone: 44' 5" x 43' 2"
 Fall Height: 7'
 Ages: 5-12

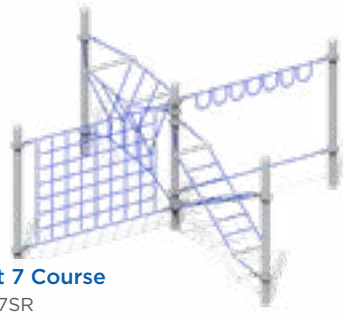

Ascend Quest 7 Course
 Model: RC-A007SR
 Use Zone: 26' 8" x 26' 8"
 Fall Height: 7'
 Ages: 5-12

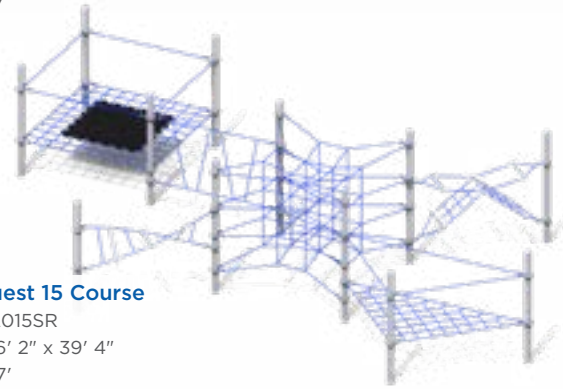

Ascend Quest 15 Course
 Model: RC-A015SR
 Use Zone: 56' 2" x 39' 4"
 Fall Height: 7'
 Ages: 5-12



Climbers



Criss Cross
 Model: 87000034XX
 Use Zone: 25' x 16'
 Height: 6'
 Ages: 5-12



Mound
 Model: 87000016XX
 Use Zone: 27' x 27'
 Height: 8'
 Ages: 5-12

Hump

Model: 87000020XX
 Use Zone: 24' x 24'
 Height: 2'
 Ages: 5-12

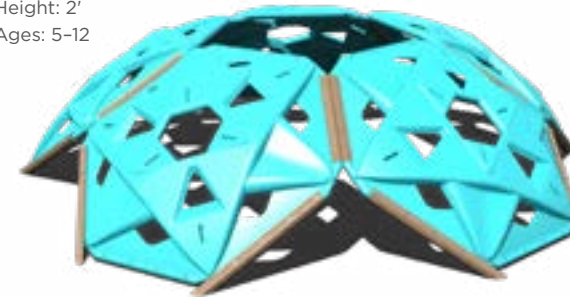

Half Arch

Model: 87000014XX
 Use Zone: 26' x 20'
 Height: 5'
 Ages: 5-12

Mini Arch

Model: 87000011XX
 Use Zone: 20' x 17'
 Height: 4'
 Ages: 5-12



Mole Hill

Model: 87000010XX
 Use Zone: 26' x 26'
 Height: 6'
 Ages: 5-12

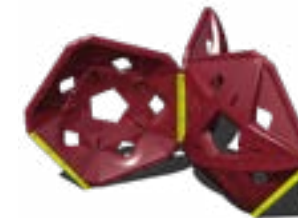

Tri-Pent

Model: 87000023XX
 Use Zone: 21' x 21'
 Height: 4'
 Ages: 5-12



Mini Half Dome

Model: 87000026XX
 Use Zone: 20' x 18'
 Height: 6'
 Ages: 5-12



Half Dome

Model: 87000024XX
 Use Zone: 27' x 20'
 Height: 10'
 Ages: 5-12

Climbers

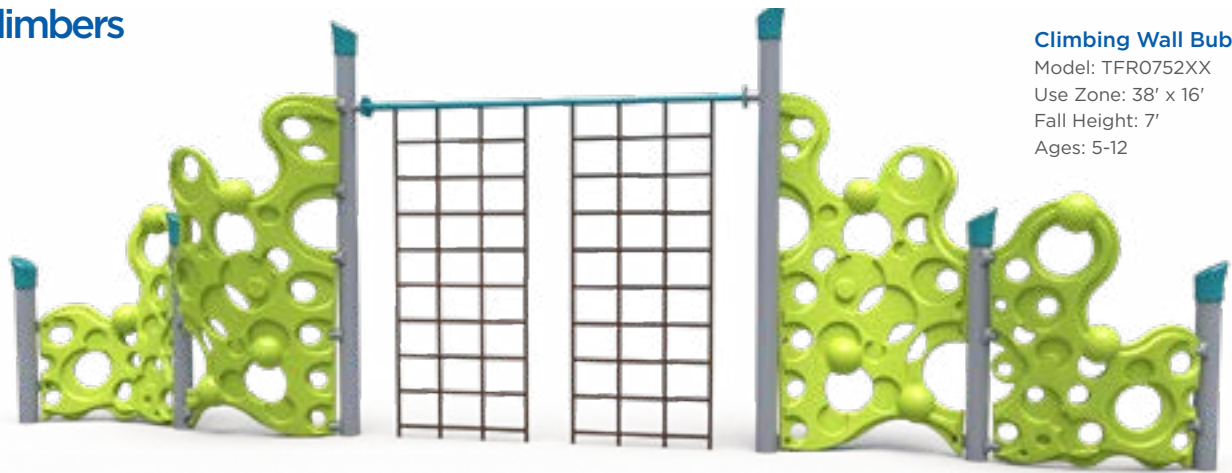

Climbing Wall Bubble Trek
 Model: TFR0752XX
 Use Zone: 38' x 16'
 Fall Height: 7'
 Ages: 5-12



Wiggle Walk Bubble Trek
 Model: TFR0750XX
 Use Zone: 38' x 16'
 Fall Height: 7'
 Ages: 5-12

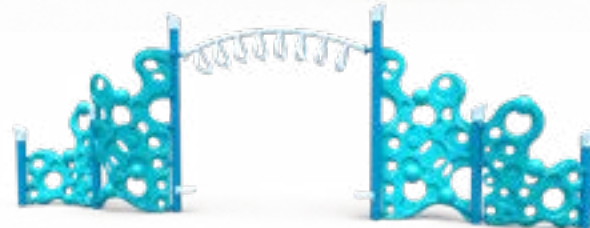

Tri-Rung Bubble Trek
 Model: TFR0751XX
 Use Zone: 38' x 16'
 Fall Height: 7'
 Ages: 5-12



Bubble Storm Climber
 Model: EFR0160XX
 Use Zone: 22' x 22'
 Ages: 5-12

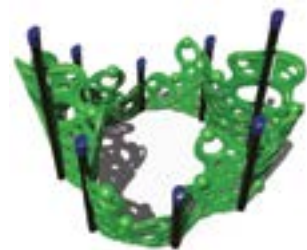

8-Section Bubble Wall Circle
 Model: EFR0070XX
 Use Zone: 26' x 26'
 Ages: 5-12

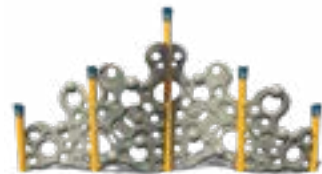

4-Section Bubble Wall
 Model: EFR0068XX
 Use Zone: 14' x 30'
 Ages: 5-12



4-Section Short Bubble Wall
 Model: EFR0158XX
 Use Zone: 14' x 30'
 Ages: 2-5

Delta Dome Climber
 Model: TFR0728XX
 Use Zone: 27' x 27'
 Fall Height: 70"
 Ages: 5-12

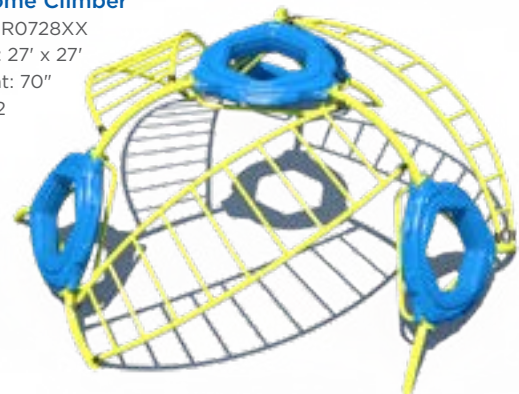

Tetra Dome Climber
 Model: TFR0674XX
 Use Zone: 31' 31" x 31' 31"
 Fall Height: 70"
 Ages: 5-12

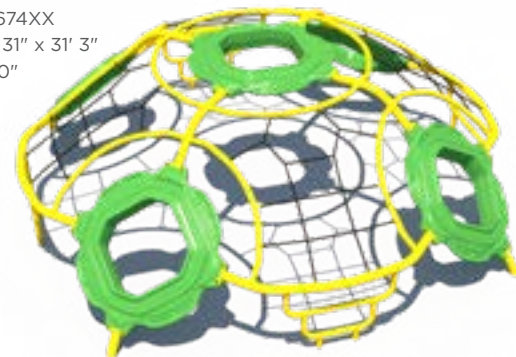

Hurricane Climber
 Use Zone: 24' x 24'
 Fall Height: 5' 6"
 Ages: 5-12
 With Shade: TFR0688XX
 Without Shade: AFR0247XX



Fire Station Climber
 Model: TFR05580XX
 Use Zone: 26' x 26'
 Ages: 5-12



Moon Crater
 Model: TFR0655XX
 Use Zone: 21' x 21'
 Height: 4 1/2'
 Ages: 2-12
 Only available in Colors Shown



Parallel Bars
 Model: 90000001XX
 Ages: 2-5, 5-12

Climbers



Teepee Climber
 Model: TFR0681XX
 Use Zone: 25' x 23'
 Height: 4'
 Ages: 2-12

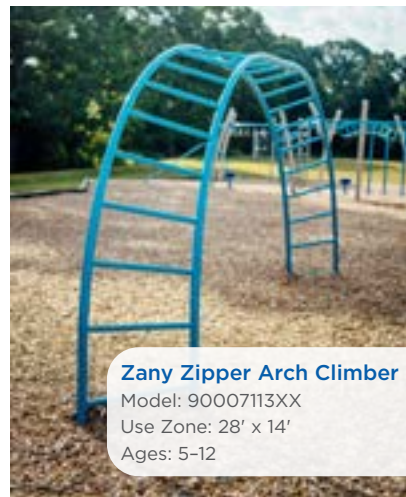

Zany Zipper Arch Climber
 Model: 90007113XX
 Use Zone: 28' x 14'
 Ages: 5-12

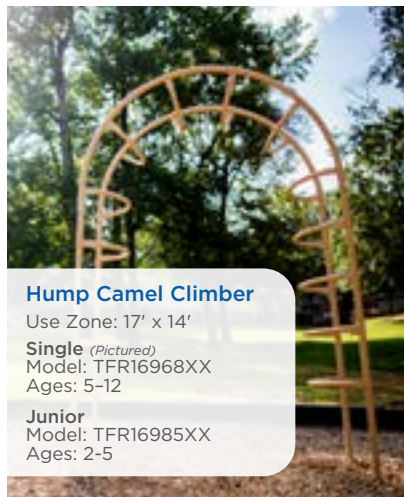

Hump Camel Climber
 Use Zone: 17' x 14'
Single (Picture)
 Model: TFR16968XX
 Ages: 5-12
Junior
 Model: TFR16985XX
 Ages: 2-5



Camel Back Kids Climber
 Model: 90007112XX
 Use Zone: 27' x 15'
 Ages: 5-12

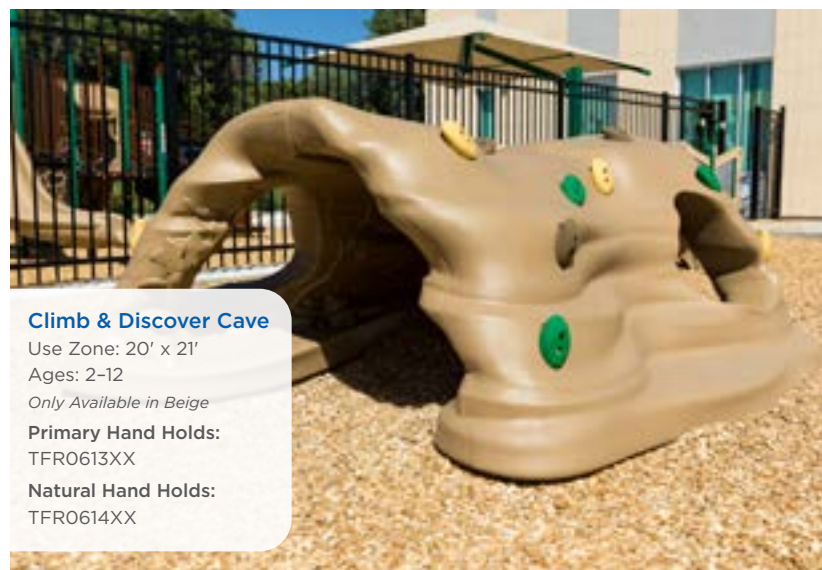

Climb & Discover Cave
 Use Zone: 20' x 21'
 Ages: 2-12
Only Available in Beige
Primary Hand Holds:
 TFR0613XX
Natural Hand Holds:
 TFR0614XX



Lateral Rock Wall
 Model: RECF0043XX
 Use Zone: 21' x 13'
 Ages: 5-12



Chain Climbing Wall
 Use Zone: 20' x 12'
 Ages: 5-12
3.5" Post
 Model: 90007103XX
5" Post
 Model: 90007003XX



Vertical Spider Net Climber
 Model: EFR0103XX
 Use Zone: 21' x 12'
 Fall Height: 9'
 Ages: 5-12



Hex Net Climber
 Model: EFR0109XX
 Fall Height: 4'
 Use Zone: 20' x 19'
 Ages: 5-12

New! **SISTEM**

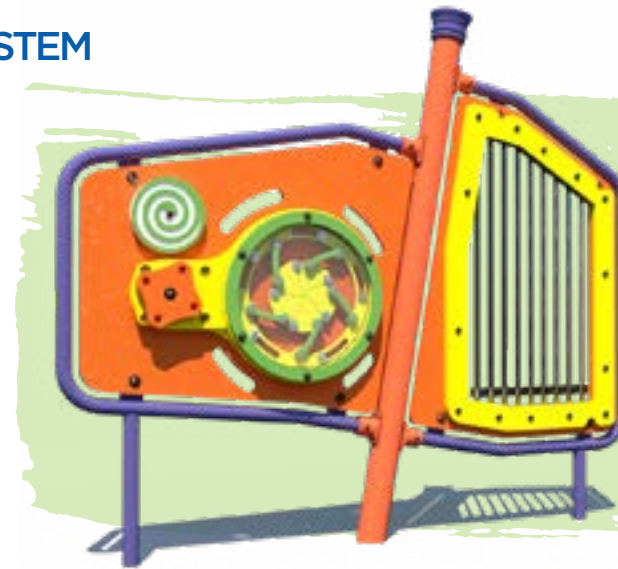

SISTEM:
 Sensory, Interactive,
 Science, Technology,
 Engineering, Math

- All ages
- No use zone requirements
- 74" wide x 6" deep
- 1 frame design features two activity panels

STEM-0004
 Size: 74" Wide x 6" Deep
 Ages: 2-5, 5-12



STEM-0001
 Size: 74" Wide x 6" Deep
 Ages: 2-5, 5-12



STEM-0002
 Size: 74" Wide x 6" Deep
 Ages: 2-5, 5-12

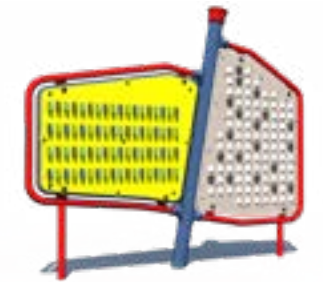

STEM-0003
 Size: 74" Wide x 6" Deep
 Ages: 2-5, 5-12



STEM-0005
 Size: 74" Wide x 6" Deep
 Ages: 2-5, 5-12



STEM-0006
 Size: 74" Wide x 6" Deep
 Ages: 2-5, 5-12



STEM-0007
 Size: 74" Wide x 6" Deep
 Ages: 2-5, 5-12



STEM-0008
 Size: 74" Wide x 6" Deep
 Ages: 2-5, 5-12

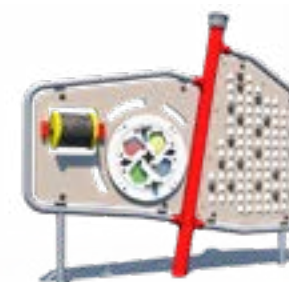

STEM-0009
 Size: 74" Wide x 6" Deep
 Ages: 2-5, 5-12



STEM-0010
 Size: 74" Wide x 6" Deep
 Ages: 2-5, 5-12



STEM-0011
 Size: 74" Wide x 6" Deep
 Ages: 2-5, 5-12



STEM-0012
 Size: 74" Wide x 6" Deep
 Ages: 2-5, 5-12

Overhead Ladders



Tri-Rung
Model: AFR0110XX
Use Zone: 16' x 21'
Ages: 5-12



Rock Face Climber
Model: TFR0664XX
Use Zone: 21' x 17'
Ages: 5-12



Trapeze Ring
Model: AFR0098XX
Use Zone: 16' x 21'
Ages: 5-12



Over Under
Model: AFR0165XX
Use Zone: 21' x 18'
Ages: 5-12



10' Track Glide
Model: AFR0118XX
Use Zone: 16' x 21'
Ages: 5-12



Three Wheel Swinger
Model: AFR0116XX
Use Zone: 16' x 21'
Ages: 5-12



360° Orbital Ladder
Model: EFR0072XX
Use Zone: 23' x 21'
Ages: 5-12



Loop Rung
Model: AFR0104XX
Use Zone: 16' x 21'
Ages: 5-12



Wavy Rung
Model: AFR0114XX
Use Zone: 16' x 21'
Ages: 5-12

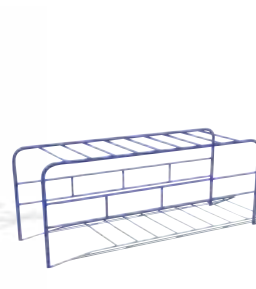

ADA Horizontal Ladder
Model: TFR16928XX
Use Zone: 23' x 16'
Ages: 5-12



Jr. Horizontal Ladder
Model: 90009000XX
Use Zone: 24' x 15'
Ages: 5-12



Chin Bar
Ages: 5-12
1 Bar: AFR0039XX
2 Bars: AFR0122XX
3 Bars: AFR0124XX

Slides



Double Straight Slide
Decks: 3' to 6'
Ages: 2-5, 5-12

Deck Height	Item Number
3'	AFR0272XX
4'	AFR0275XX
5'	AFR0279XX
6'	AFR0283XX



Single & Double Turn Slide
Left Config.: 4' Deck Height
Right Config.: 3' to 5' Deck Heights
Ages: 2-5, 5-12

Deck Height	Curves To	Item Number
3'	Right	AFR0273XX
4'	Left	AFR0276XX
	Right	AFR0277XX
5'	Right	AFR0280XX
	Right Turn Double	AFR0281XX



Single Straight Slide
Decks: 3' to 8'
Ages: 2-5, 5-12

Deck Height	Item Number
3'	AFR0271XX
4'	AFR0274XX
5'	AFR0278XX
6'	AFR0282XX
8'	AFR0284XX



Single Stainless Steel Slide
Decks: 3' to 8'
Ages: 2-5, 5-12

Deck Height	Item Number
3'	AFR0285XX
4'	AFR0286XX
5'	AFR0287XX
6'	AFR0288XX
8'	AFR0289XX



Double Stainless Steel Slide
Decks: 3' to 8'
Ages: 2-5, 5-12

Deck Height	Item Number
3'	AFR0290XX
4'	AFR0291XX
5'	AFR0292XX
6'	AFR0293XX
8'	AFR0294XX

Open Spiral Slide
Model: AFR0243XX
Use Zone: 18' x 25'
Height: 6'
Ages: 5-12



Motion

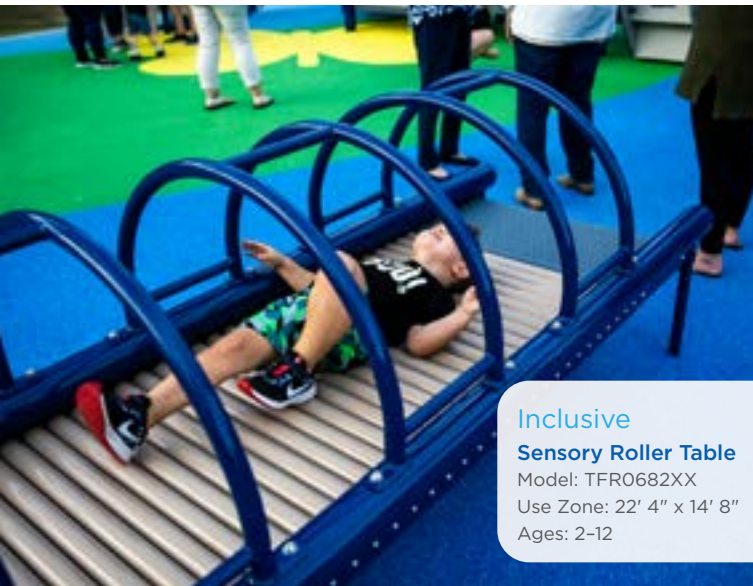

Inclusive Sensory Roller Table
Model: TFR0682XX
Use Zone: 22' 4" x 14' 8"
Ages: 2-12



Quad Saw
Model: TFR0736XX
Use Zone: 22' x 18'
Ages: 5-12



Cozy Pod Spinner
Model: TFR0638XX
Use Zone: 22' x 22'
Ages: 2-12
Only Available in Colors Shown



Tea Cup Spinner
Model: TFR17548XX
Use Zone: 16' 4" x 16' 4"
Ages: 2-12

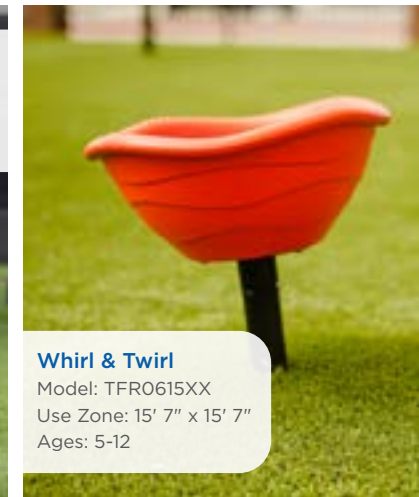

Whirl & Twirl
Model: TFR0615XX
Use Zone: 15' 7" x 15' 7"
Ages: 5-12



Classic Teeter II
Model: 90017009XX
Use Zone: 22' x 13'
Ages: 5-12

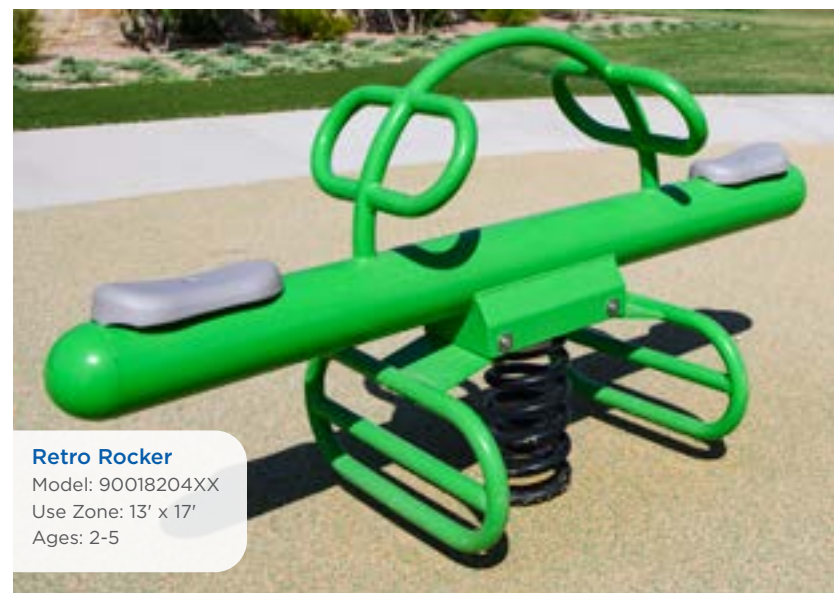

Retro Rocker
Model: 90018204XX
Use Zone: 13' x 17'
Ages: 2-5



Inclusive Inclusive Orbit
Model: PLD0010SM
Use Zone: 20' x 20'
Ages: 5-12
Surface Mount Only

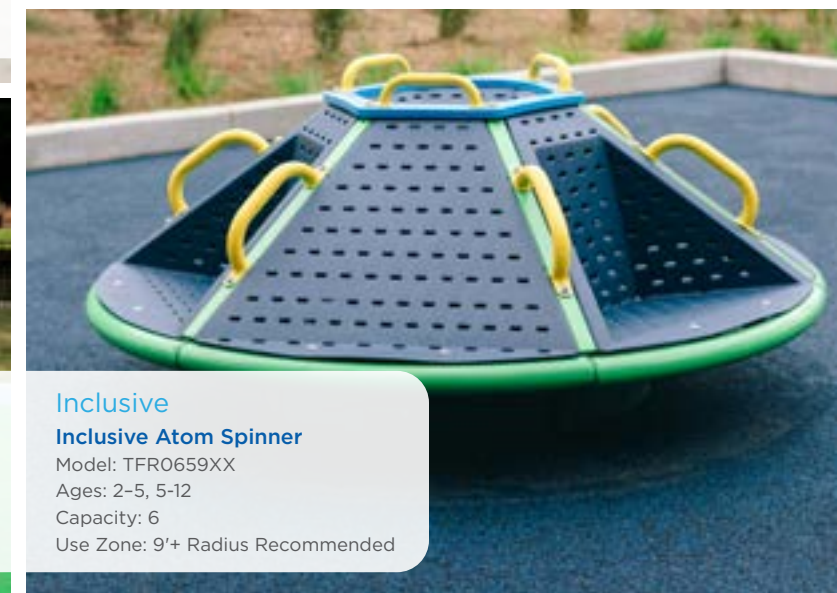

Inclusive Inclusive Atom Spinner
Model: TFR0659XX
Ages: 2-5, 5-12
Capacity: 6
Use Zone: 9'+ Radius Recommended



4-Seat See-Saw
Model: TFR0684XX
Use Zone: 21' x 14'
Ages: 2-5, 5-12



Surf Rider
Model: 90018002XX
Use Zone: 14' x 17'
Ages: 5-12



Hurricane Spinner
Model: TFR16610XX
Use Zone: 18' x 18'
Ages: 5-12



Spin About
Model: TFR08714XX
Use Zone: 14' x 14'
Ages: 5-12



Inclusive Gravity Bowl
Model: PLD0005XX
Use Zone: 14' 9" x 14' 9"
Ages: 2-12



Aero Whirl
Model: PLD0007XX
Use Zone: 23' x 23'
Ages: 5-12



Spinner
Model: PLD0004XX
Use Zone: 14' x 14'
Ages: 2-12



Rota Rock
Model: PLD0011XX
Use Zone: 18' x 18'
Ages: 5-12

Motion

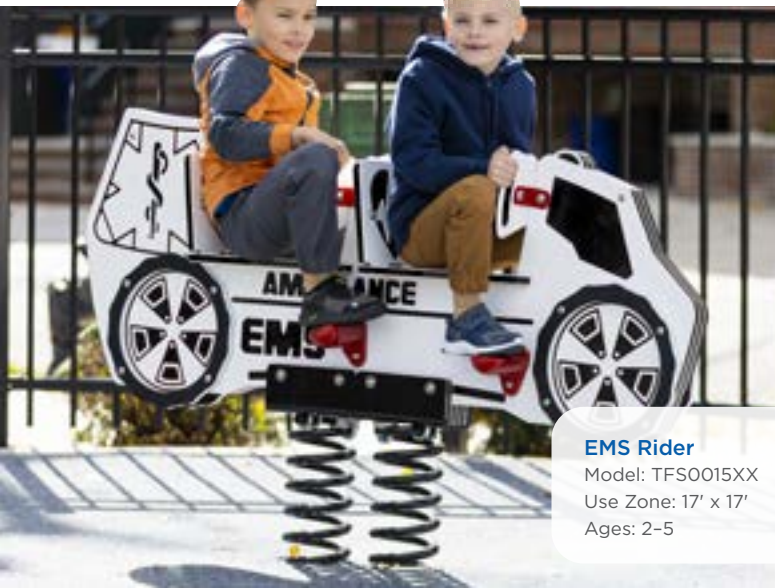

EMS Rider
Model: TFS0015XX
Use Zone: 17' x 17'
Ages: 2-5



Moon Buggy
Use Zone: 17' x 17'
Ages: 2-5
1 Seat: TFS0036XX
2 Seat: TFS0031XX

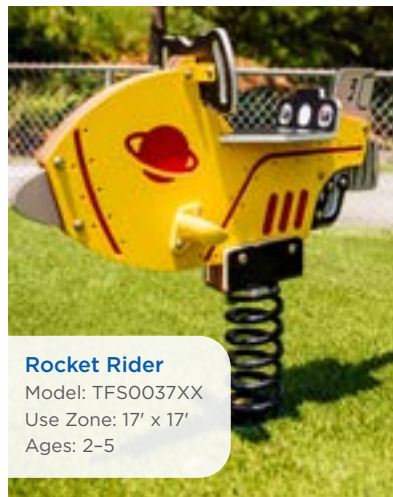

Rocket Rider
Model: TFS0037XX
Use Zone: 17' x 17'
Ages: 2-5



Horse Rider
Model: TFS0026XX
Use Zone: 17' x 17'
Ages: 12-23 Months, 2-5

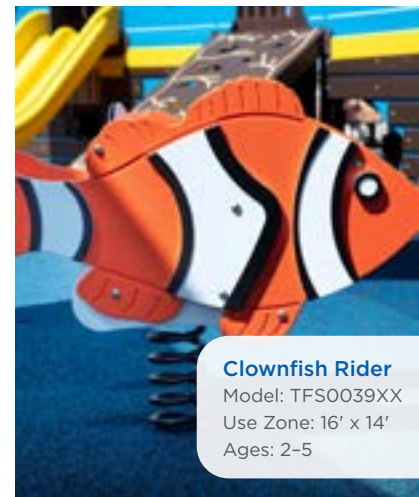

Clownfish Rider
Model: TFS0039XX
Use Zone: 16' x 14'
Ages: 2-5

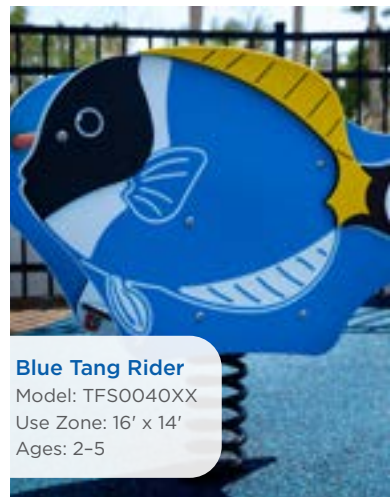

Blue Tang Rider
Model: TFS0040XX
Use Zone: 16' x 14'
Ages: 2-5



Fire Truck Rider
Model: TFS0022XX
Use Zone: 17' x 17'
Ages: 2-5



Police Rider
Model: TFS0014XX
Use Zone: 17' x 17'
Ages: 2-5



Jet Rider
Model: TFS0046XX
Use Zone: 17' x 17'
Ages: 2-5



Trout Rider
Model: TFS0029XX
Use Zone: 17' x 17'
Ages: 12-23 Months, 2-5



Shuttle Rider
Model: TFS0047XX
Use Zone: 17' x 17'
Ages: 2-5



Motorcycle Rider
Use Zone: 17' x 17'
Ages: 2-5
1 Seat: TFS0025XX
2 Seat: TFS0023XX



Wally the Whale Rider
Model: 90018201XX
Use Zone: 17' x 17'
Ages: 2-12



Freddie the Frog Rider
Model: 90018202XX
Use Zone: 17' x 17'
Ages: 2-12



Pig Rider
Model: TFS0027XX
Use Zone: 17' x 17'
Ages: 12-23 Months, 2-5



Alligator Rider
Model: TFR0510XX
Use Zone: 17' x 17'
Ages: 2-5



Turtle Rider
Model: TFS0048XX
Use Zone: 17' x 17'
Ages: 2-5, 5-12



Bear Rider
Model: TFS0020XX
Use Zone: 17' x 17'
Ages: 12-23 Months, 2-5



Stegosaurus Rider
Model: TFS0032XX
Use Zone: 17' x 17'
Ages: 12-23 Months, 2-5



Lion Rider
Model: TFS0028XX
Use Zone: 17' x 17'
Ages: 12-23 Months, 2-5

Motion



Single Post Swing Frame Without Shade



Single Post Swing Frame With Standard Shade



Arch Swing Frame

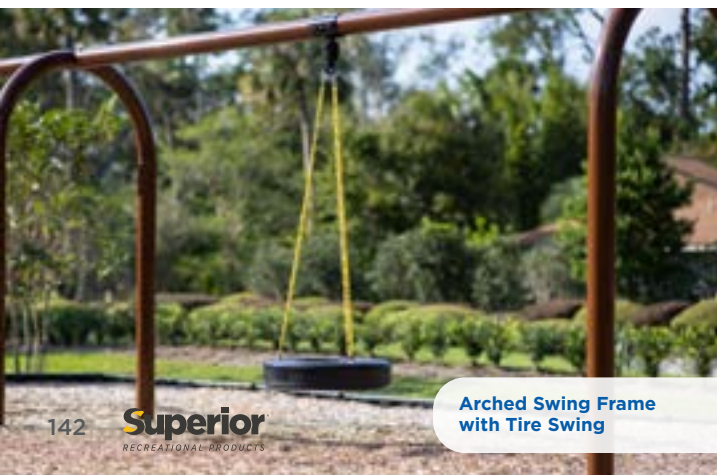

Arched Swing Frame with Tire Swing

Swing Frames & Zip Line

Single Post Swing Frames

Constructed from 5" (without shade) or 6 5/8" (with shade) diameter steel, these frames feature an 8' height and are available with or without shade. Version with shade is IPEMA Certified and ASTM F1487-17 Compliant.

Without Shade

Bays	Item Number	Use Zone
1	TFR0622XX	24' x 32'
2	TFR0623XX	36' x 32'
3	TFR0624XX	47' x 32'
4	TFR0625XX	59' x 32'
Add-A-Bay	TFR0627XX	Add 11' x 32'

With Standard Shade

Bays	Item Number	Use Zone
1	RSW23516G	24' x 32'
2	RSW3516G	36' x 32'
3	RSW46516G	47' x 32'
4	RSW5816G	58' x 32'



Add-On Cantilever Swing

Our Cantilever Swing is an add-on swing option for our Single Post Swing Frame Without Shade. Product includes a bucket seat, fittings, and a horizontal arm.

Ages 6-23 Months Model: EFR0150XX
Ages 24-47 Months Model: EFR0148XX

Arch Swing Frame

For Traditional Swing Seats

Post Size	Bays	Item Number	Use Zone
3.5"	1	TFR3501XX	24' x 32'
	2	TFR3502XX	36' x 32'
	3	TFR3503XX	48' x 32'
	4	TFR3504XX	58' x 32'
	Add-A-Bay	TFR3500XX	Add 11' x 32'
5"	1	EFR0116XX	24' x 32'
	2	EFR0117XX	36' x 32'
	3	EFR0118XX	48' x 32'
	4	EFR0119XX	58' x 32'
	Add-A-Bay	EFR0120XX	Add 11' x 32'

For Tire Swings

Our tire swing frame is made from 5" steel tubing.

Bays	Item Number	Use Zone
1	90015991XX	22' x 28'
2	90015992XX	22' x 44'
3	90015993XX	22' x 59'
4	90015994XX	22' x 74'
Add-A-Bay	90945900XX	Add 11' x 22'

Standard Swing Frames

Constructed from 2 3/8" galvanized steel tubing with cast aluminum junctions, these swing frames feature an 8' or 10' height. The part numbers below are for galvanized frames. To order a powder coated frame for an upcharge, replace "XX" with "PC" in the part number.

Bi-Pod

Available in an 8' height only.

Bays	Item Number	Use Zone
1	90015401XX	25' x 32'
2	90015402XX	36' x 32'
3	90015403XX	47' x 32'
Add-A-Bay	90915400XX	Add 11' x 32'



Tri-Pod

Height	Bays	Item Number	Use Zone
8'	1	90015301XX	33' x 32'
	2	90015302XX	45' x 32'
	3	90015303XX	56' x 32'
	Add-A-Bay	90015300XX	33' x 32'
10'	1	90015311XX	36' x 40'
	2	90015312XX	47' x 40'
	3	90015313XX	58' x 40'
	Add-A-Bay	90015319XX	Add 11' x 32'

Inclusive Team Swing

Frame	Standard	Add-A-Bay
3.5"	PLD0018XX	PLD0019XX
5"	PLD0021XX	PLD0022XX



Zip Line

Ages: 5-12

75' Length

Model: EFR0132XX
Use Zone: 105' x 22'

100' Length

Model: EFR0128XX
Use Zone: 128' x 22'

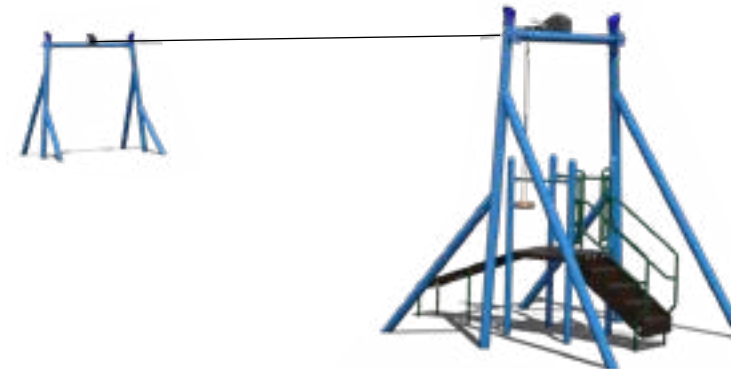



Swing Seats & Accessories



See Me Swing

The See Me Swing is designed to allow adult and child to swing while face to face.

Ages 6-23 Months
Model: TFR0660XX
Bucket Seat Only Available in Black

Ages 24-47 Months
Model: TFR0662XX



Belt Seats

Our molded belt seats feature galvanized triangle hardware and high carbon steel spring inserts to resist vandalism. Available in red, yellow, green, blue, black, and tan. Galvanized or yellow PVC coated chain is available. **Sold as a set of two.**

Chain Type	Chain Link	Item Number
Galvanized	8'	90015108XX
	10'	90015110XX
Yellow PVC	8'	90015208XX
	10'	90015210XX



Bucket Seats

Our full bucket seats feature high backs and full stainless steel inserts. These seats are available as for ages 24-47 months with 54" chains in red, yellow, green, blue, or black. **Sold as a set of two.**

Chain Type	Item Number
Galvanized	90015130XX
Yellow PVC	90015230XX



Tire Swing Seats

Our Tire Swing Seat includes one tire and all galvanized chains and hardware. Order one item number per bay. Tires are made from durable, black roto-molded plastic.
Model: TFR0612XX

New!

Inclusive Swing Seat



Our patent-pending Inclusive Swing Seat includes two swing seats and all chains and hardware.
Ages: 5-12
Model: TFR0768XX



Beveled Swing Mat
40" x 40" x 1 1/2"
Model: WM-05

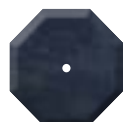

Spinner Mat
8' Octagon
6" Inch Center Hole
Model: TFR0718XX

Games



Run from daisy to daisy as they light up to see how many you can touch before the clock runs out. **No power source required.**

Inclusive DaisyDash™
Model: DD1508IG
Dimensions: 15' Dia. x 8' Height
Ages: 2-12



Impact Attenuating Surfacing Recommended



Soccer Goals Set

Model: 60019202XX
Ages: 2-12
Dimensions: 12' x 6' Height
Includes Two Goals with Nets
Replacement Nets
MSC-1585XX



Triple Toss

Model: TRT-10
Ages: 2-12
Replacement Triple Toss
TRT-03



Tether Ball

Model: 60019301XX
Ages: 2-12
Replacement Ball with Cord
60019311XX

Nature-Inspired Play



Stepping Boulders Set
 Model: UP501
 Clearance Zone: 13' 11" x 20'
 Ages: 5-12
 Includes 3 Boulders

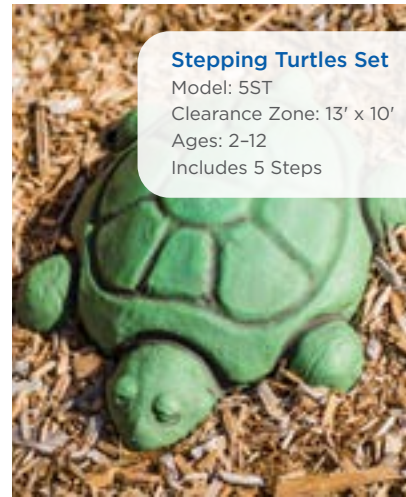

Stepping Turtles Set
 Model: 5ST
 Clearance Zone: 13' x 10'
 Ages: 2-12
 Includes 5 Steps

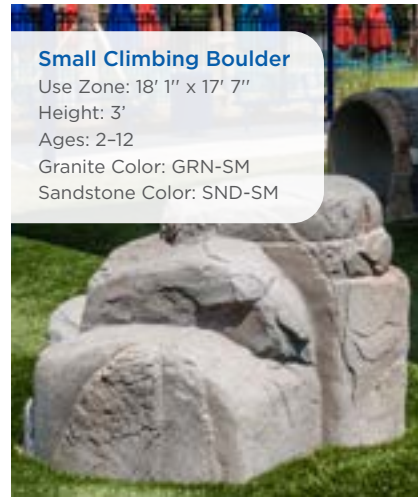

Small Climbing Boulder
 Use Zone: 18' 1" x 17' 7"
 Height: 3'
 Ages: 2-12
 Granite Color: GRN-SM
 Sandstone Color: SND-SM

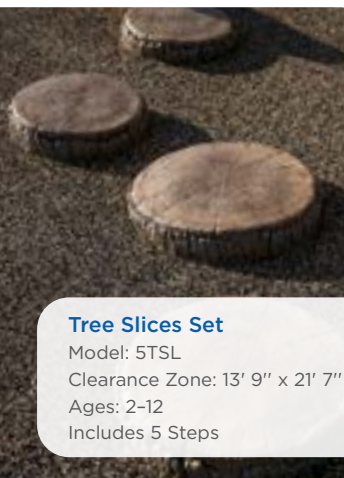

Tree Slices Set
 Model: 5TSL
 Clearance Zone: 13' 9" x 21' 7"
 Ages: 2-12
 Includes 5 Steps

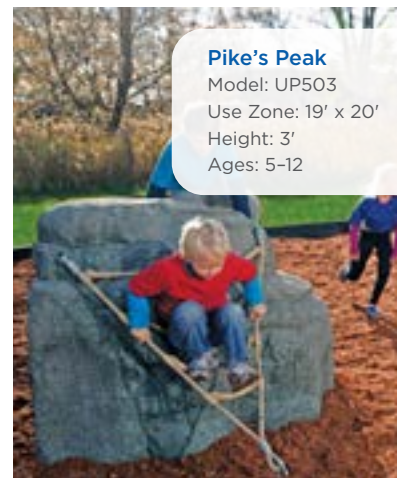

Pike's Peak
 Model: UP503
 Use Zone: 19' x 20'
 Height: 3'
 Ages: 5-12

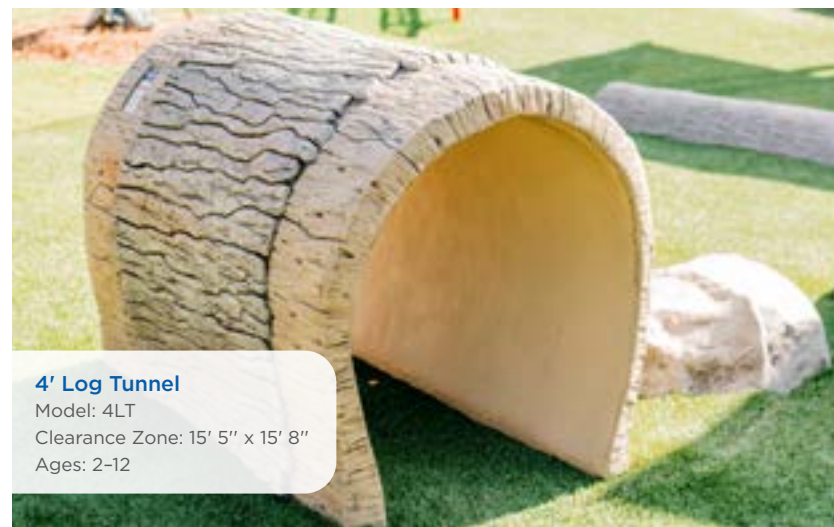

4' Log Tunnel
 Model: 4LT
 Clearance Zone: 15' 5" x 15' 8"
 Ages: 2-12



6' Half Log Beam
 Model: 6HL
 Clearance Zone: 18' x 14'
 Ages: 2-12

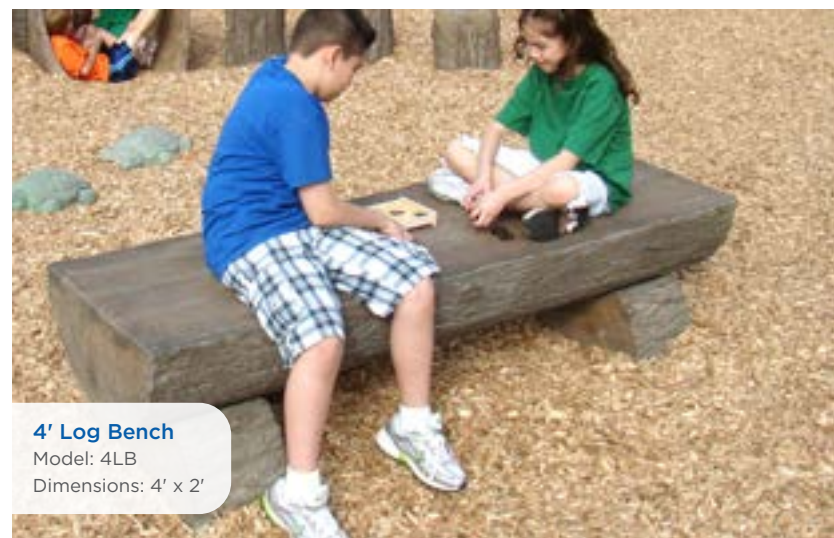

4' Log Bench
 Model: 4LB
 Dimensions: 4' x 2'

Nature-Inspired Play & Balance

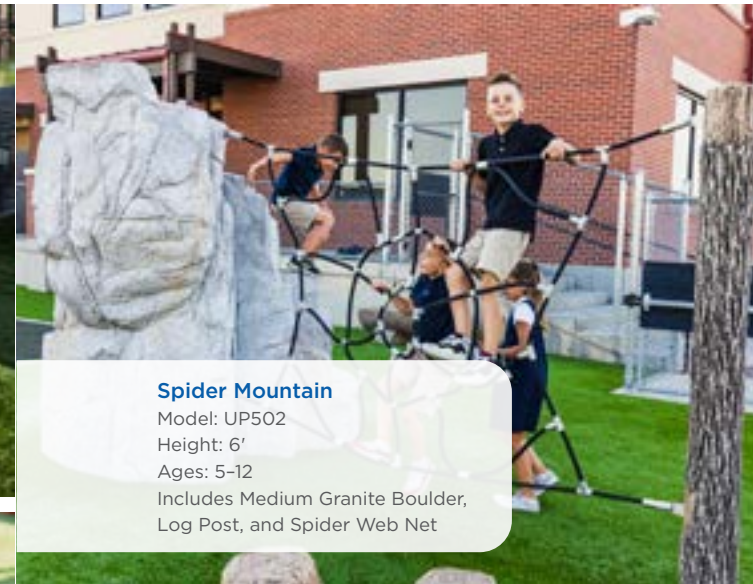

Spider Mountain
 Model: UP502
 Height: 6'
 Ages: 5-12
 Includes Medium Granite Boulder, Log Post, and Spider Web Net

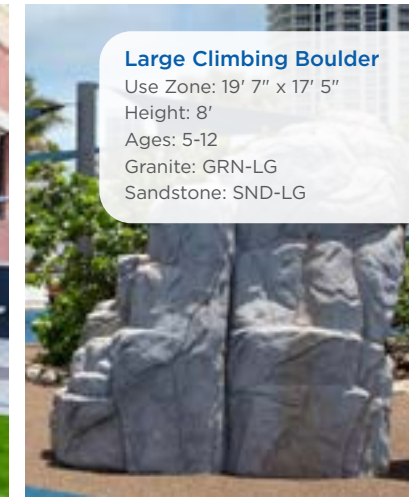

Large Climbing Boulder
 Use Zone: 19' 7" x 17' 5"
 Height: 8'
 Ages: 5-12
 Granite: GRN-LG
 Sandstone: SND-LG

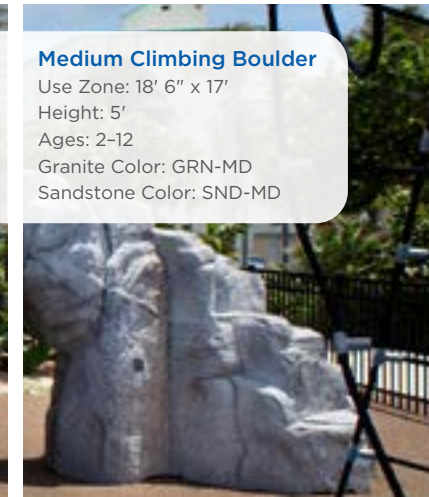

Medium Climbing Boulder
 Use Zone: 18' 6" x 17'
 Height: 5'
 Ages: 2-12
 Granite Color: GRN-MD
 Sandstone Color: SND-MD

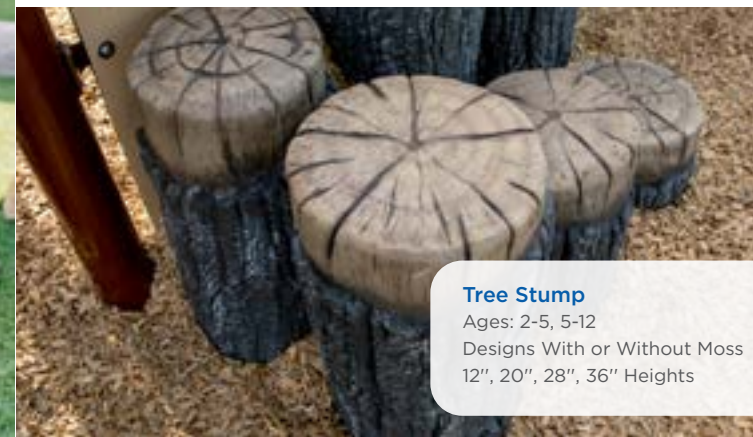

Tree Stump
 Ages: 2-5, 5-12
 Designs With or Without Moss
 12", 20", 28", 36" Heights



Rubber Mushrooms
 Top Diameter: 18"
 Ages: 2-5, 5-12
 Only Available in Colors Shown
 11.5" Height: MS-02XX
 15.5" Height: MS-03XX
 19.5" Height: MS-04XX



Play Spheres
 Ages: 2-5, 5-12
 Required Mounting Kit Sold Separately.
 In-Ground Mounting Kit: TFR0716XX
 Surface Mounting Kit: TFR0717XX

Style	Size	Item Number
Half	14"	TFR0704XX
	20"	TFR0706XX
Full	28"	TFR0708XX
	14"	TFR0705XX
	20"	TFR0707XX
	28"	TFR0709XX

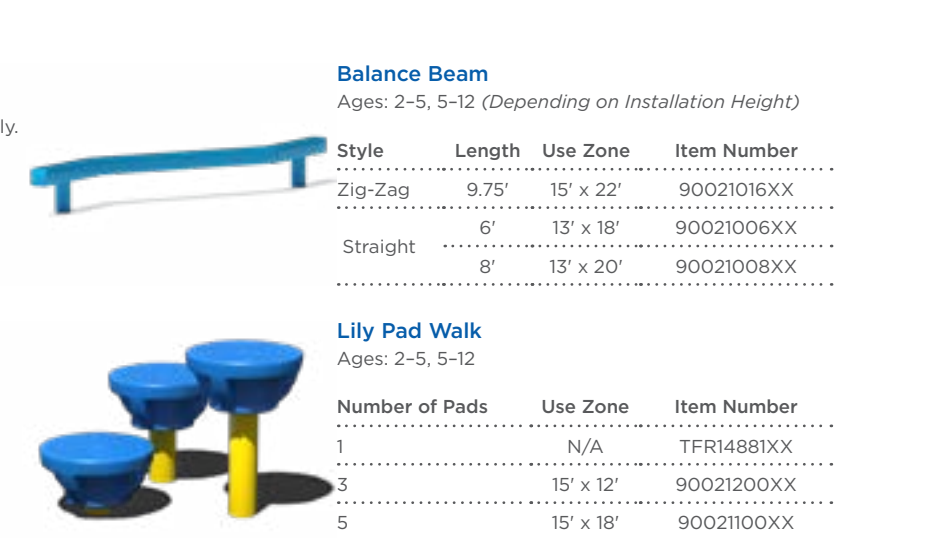

Balance Beam
 Ages: 2-5, 5-12 (Depending on Installation Height)

Style	Length	Use Zone	Item Number
Zig-Zag	9.75'	15' x 22'	90021016XX
Straight	6'	13' x 18'	90021006XX
	8'	13' x 20'	90021008XX

Lily Pad Walk
 Ages: 2-5, 5-12

Number of Pads	Use Zone	Item Number
1	N/A	TFR14881XX
3	15' x 12'	90021200XX
5	15' x 18'	90021100XX

Musical Play



Lady Bug Drum
Model: 77149

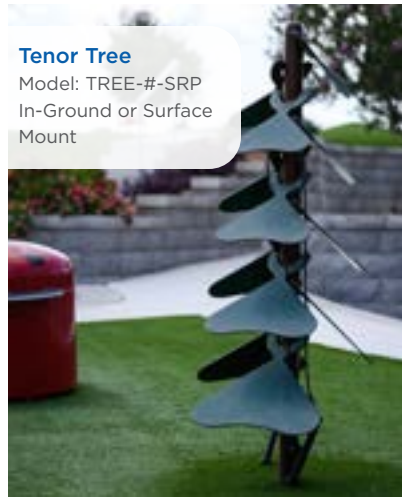

Tenor Tree
Model: TREE-#-SRP
In-Ground or Surface Mount

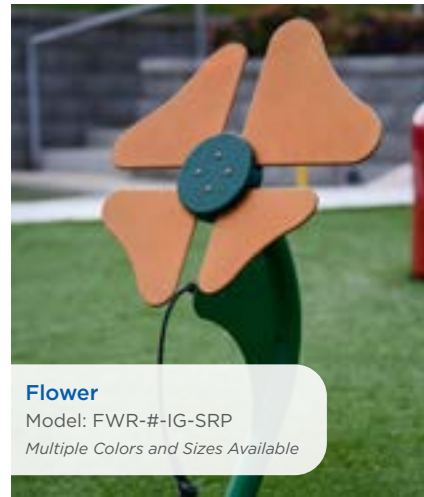

Flower
Model: FWR-#-IG-SRP
Multiple Colors and Sizes Available



Mushroom
Model: MUSH-#-IG-SRP
Multiple Sizes Available

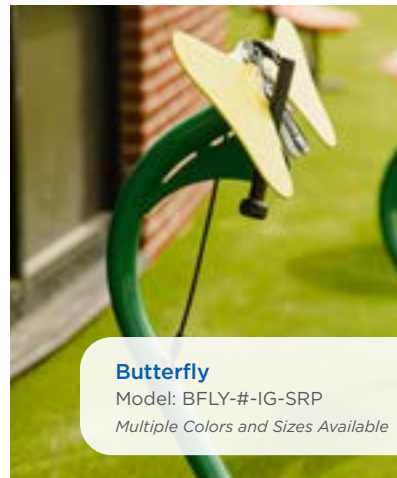

Butterfly
Model: BFLY-#-IG-SRP
Multiple Colors and Sizes Available



Tuned Drums
Model: TD-IG-N-SRP
Includes In-Ground Mount Kit
Cap Colors: Rainbow or Natural



Contrabass Chimes
Model: CCH-IG-SRP
Includes In-Ground Mount

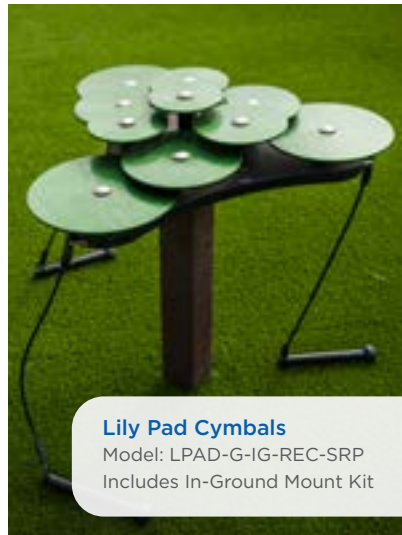

Lily Pad Cymbals
Model: LPAD-G-IG-REC-SRP
Includes In-Ground Mount Kit

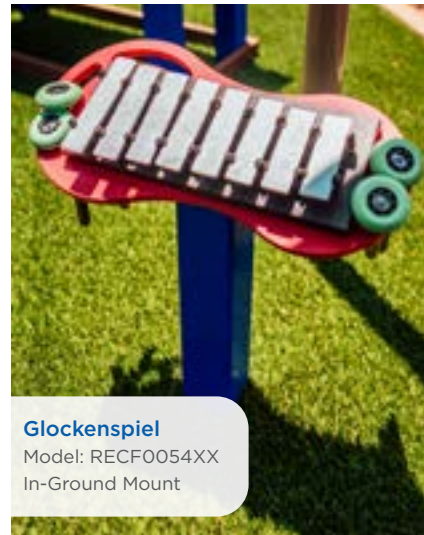

Glockenspiel
Model: RECF0054XX
In-Ground Mount

Musical Play

Additional Mallets Sold Separately
Inclusive Mallets Also Available



Solo with Aluminum Keys
Model: TFR0745XX
Includes In-Ground Mount Kit



Solo with Fiberglass Keys
Model: TFR0746XX
Includes In-Ground Mount Kit



Composer
Model: TFR0748XX
Includes In-Ground Mount Kit



Duo
Model: TFR0747XX
Includes In-Ground Mount Kit



Harp
Model: HRP-IG-SRP
Includes Surface/In-Ground Mount



Melody
Model: MELD-#-REC-SRP
In-Ground or Surface Mount



Calypso
Model: CPSO-#-IG-SRP
Green (G) or Gray (S) Posts



Swirl
Model: SWRL-#-REC-SRP
In-Ground or Surface Mount



Imbarimba
Model: IMBA-#-REC-SRP
In-Ground or Surface Mount



Pegasus
Model: PEG-#-REC-SRP
In-Ground or Surface Mount



Griffin
Model: GRIF-#-REC-SRP
In-Ground or Surface Mount



Pagoda Bells
Model: PBEL-IG-REC-SRP
Includes In-Ground Mount



Manta Ray
Model: MRAY-IG-SRP
Includes Surface/In-Ground Mount



Rhythm
Model: RHYT-#-REC-SRP
In-Ground or Surface Mount



Single Post Bongos
Model: RECF0155XX
In-Ground Mount



Caterpillar
Model: CATR-#-SRP
In-Ground or Surface Mount

Dramatic Play



Deluxe Gas Station Facade
Model: PS3-26835
Ages: 2-5, 5-12



Trike Track
Model: PS3-28227
Includes: Freestanding Gas Station Facade, Freestanding Store Front, a pair of Talk Tubes, and three Traffic Signs
Rubber track and Ground Level Arch Bridge not included.



Trike Shed
Model: RECF0081XX



Standard Gas Station Facade
Model: 90000004XX
Ages: 2-5, 5-12



Ground Level Arch Bridge
Model: AFR0008XX
Ages: 2-12



Talk Tube
Ages: 2-5, 5-12
Mount: In-ground
3.5" Post: TFR04700XX
5" Post: TFR04699XX

Traffic Signs



Railroad Crossing
Model: TFR12150XX
Size: 24" x 24"



Traffic Light
Model: TFR16072XX
Size: 10" x 32"



Stop
Model: TFR08297XX
Size: 24" x 24"



Yield
Model: TFR09022XX
Size: 24¼" x 24¼"



No Parking
Model: TFR12151XX
Size: 20" x 24"

Dramatic Play



Metro Fire Truck
Spring Mounted Model: 46514*
Post Mounted Model: 49220
Ages: 2-5
*Use Zone: 20' x 16'

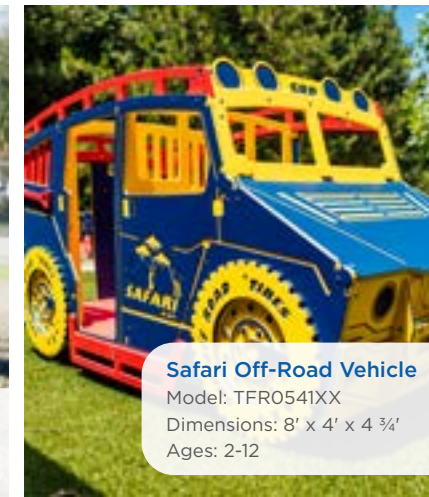

Safari Off-Road Vehicle
Model: TFR0541XX
Dimensions: 8' x 4' x 4 ¾'
Ages: 2-12

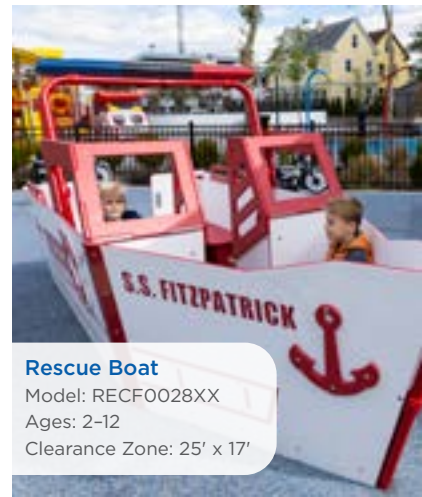

Rescue Boat
Model: RECF0028XX
Ages: 2-12
Clearance Zone: 25' x 17'



Stage Coach
Model: EFR0123XX
Ages: 2-12
Use Zone: 20' x 16'



Vintage Military Vehicle
Model: TFR0579XX
Ages: 2-5



School Bus
Spring Mounted: 46515*
Post Mounted: 49221
Ages: 2-5
*Use Zone: 20' x 16'



Lifeguard Vehicle
Model: TFR0653XX
Ages: 2-12
Clearance Zone: 17' x 13'



Ambulance
Spring Mounted: 46520
Post Mounted: 47507
Ages: 2-5
Use Zone: 20' x 16'



Off-Road Truck
Model: 49222
Ages: 2-5
Clearance Zone: 16' x 11'

What's the difference between a use zone and a clearance zone? A use, or safety, zone is the amount of required clear space around play equipment. A clearance zone is the suggested amount of clear space when no use zone is required.



Play Components

- 154** Climbers
- 158** Bridges & Connectors
- 161** Active
- 162** Overhead Events
- 163** Slides
- 165** Activity Panels
- 169** Panel Accessories & Decks
- 170** Ramps & Stairs
- 171** Roofs
- 172** Modular Shade

Climbers



Zany Climber
5' to 8' Decks
Ages: 5-12



Lava Climber
3' to 6' Decks
Ages: 2-12

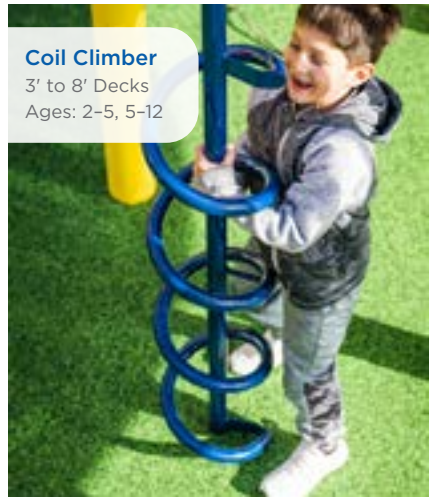

Coil Climber
3' to 8' Decks
Ages: 2-5, 5-12



Clover Climber
2' to 8' Decks
Ages: 2-5, 5-12

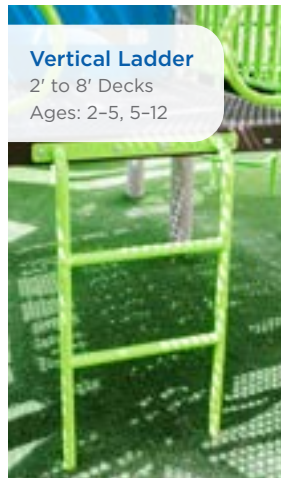

Vertical Ladder
2' to 8' Decks
Ages: 2-5, 5-12

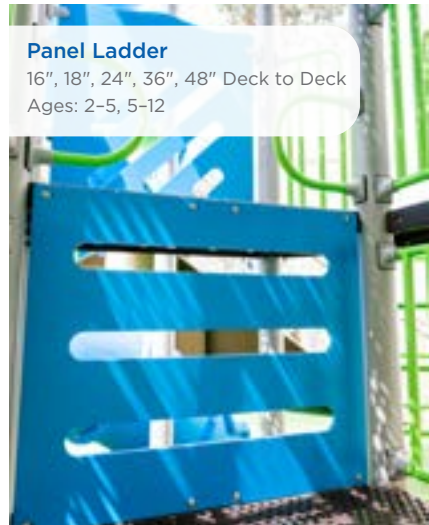

Panel Ladder
16", 18", 24", 36", 48" Deck to Deck
Ages: 2-5, 5-12



Spiral Climber
2' to 8' Decks
Ages: 2-5, 5-12

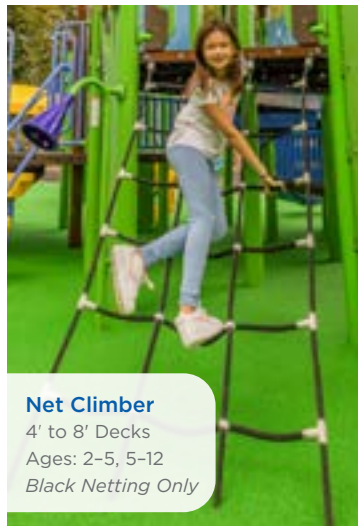

Net Climber
4' to 8' Decks
Ages: 2-5, 5-12
Black Netting Only



Bubble Ladder
4', 6', 8' Decks
Ages: 2-5, 5-12



Mountain Climber
3' and 5' Decks Only
Ages: 5-12



Delta Spiral Climber
4' and 6' Decks
Left and Right Config.
Ages: 2-5, 5-12



Delta Mountain Climber
3' to 6' Decks
Ages: 2-5, 5-12



Tetra Double Climber
3' to 6' Decks
Ages: 2-5, 5-12



Tetra Twist Climber
3' to 8' Decks
Ages: 2-5, 5-12



Hex Membrane Climber
4' to 8' Decks
5' Posts
Ages: 5-12

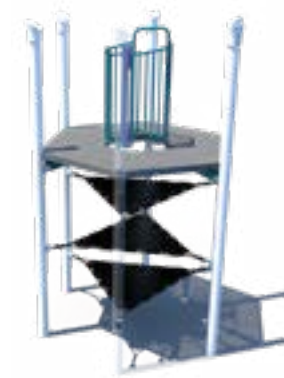

Tri Membrane Climber
4' to 8' Decks
5' Posts
Ages: 5-12



Astro Climber
3' to 4' Decks
Ages: 2-12

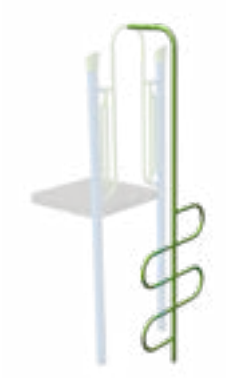

Tree Climber
2' to 8' Decks
Ages: 2-5, 5-12



Sliding Pole
2' to 6' Decks
Ages: 5-12



Sail Climber
3' to 8' Decks
Ages: 2-5, 5-12



Quick Climber
2' to 8' Decks
Ages: 2-5, 5-12



Zipper Climber
3' to 8' Decks
Ages: 2-5, 5-12

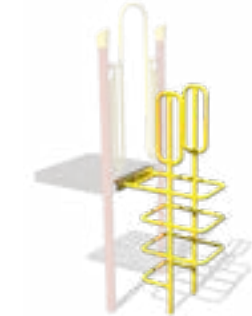

Man Hole Climber
2' to 8' Decks
Ages: 5-12



Disk Climber
Deck Must Be Even or Higher Than Top Disk
Ages: 2-5, 5-12



Ribbon Climber
3' to 8' Decks
Ages: 5-12

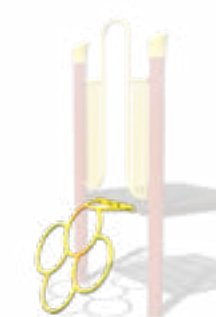

Ring Climber
3' Decks Only
Ages: 2-5, 5-12



PVC Cargo Net Climber
2' to 5' Decks
Ages: 2-5, 5-12



Hex Net Climber
4' to 6' Decks
Ages: 2-5, 5-12
Black Netting Only

Climbers



Delta Arch Climber
4', 5', and 6' Decks Only
Ages: 5-12



Lily Pad Climber
2' and 3' Decks Only
Ages: 2-5, 5-12



Delta Vertical Climber
1' to 4' Decks
Ages: 2-5, 5-12
Also Available with Tetra

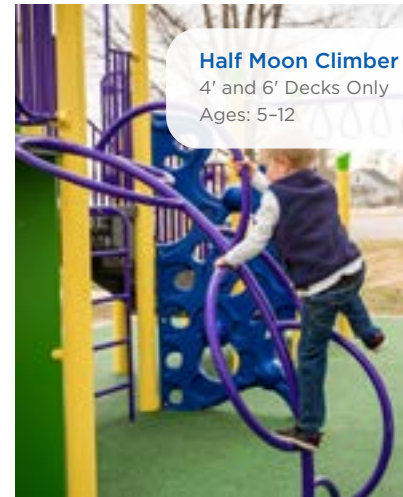

Half Moon Climber
4' and 6' Decks Only
Ages: 5-12

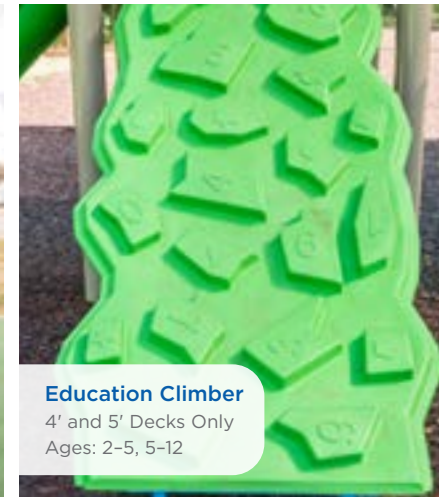

Education Climber
4' and 5' Decks Only
Ages: 2-5, 5-12



Concentration Climber
2' to 8' Decks
Ages: 2-5, 5-12

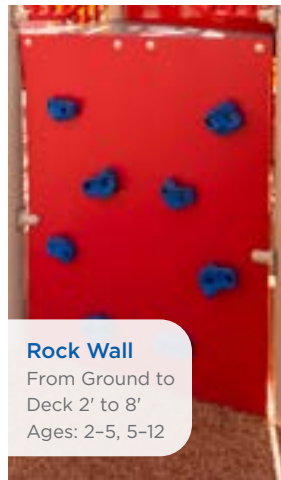

Rock Wall
From Ground to Deck 2' to 8'
Ages: 2-5, 5-12



Bubble Wall
Up to 4' Decks
Ages: 2-5, 5-12

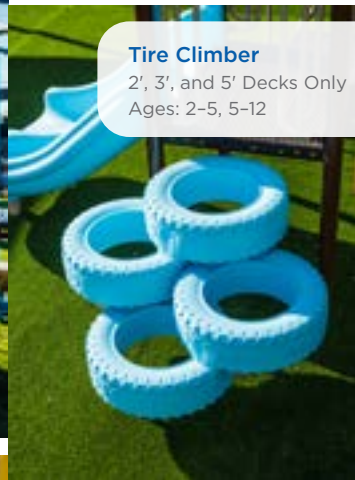

Tire Climber
2', 3', and 5' Decks Only
Ages: 2-5, 5-12

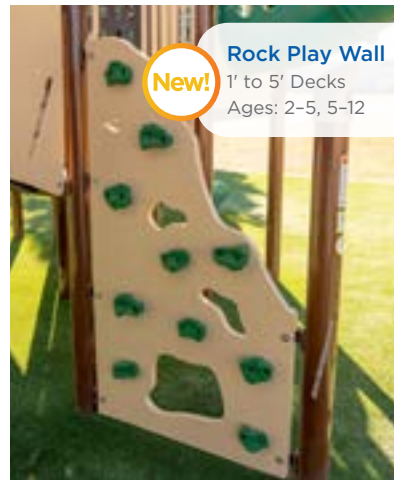

New! **Rock Play Wall**
1' to 5' Decks
Ages: 2-5, 5-12



Pent Climber
3' and 5' Decks Only
Ages: 2-5, 5-12

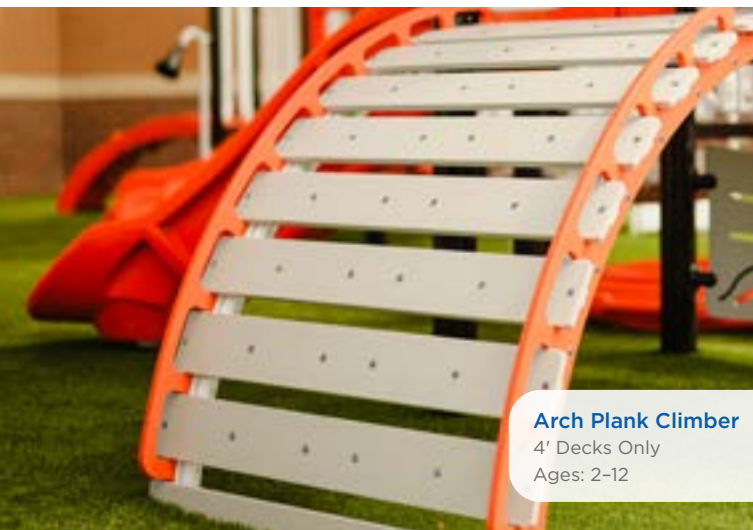

Arch Plank Climber
4' Decks Only
Ages: 2-12



Loop Climber
3' and 4' Decks Only
Ages: 2-5, 5-12



Chain Link Climber
4' and 5' Decks Only
Ages: 2-5, 5-12

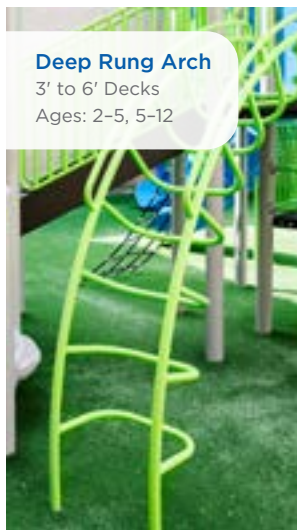

Deep Rung Arch
3' to 6' Decks
Ages: 2-5, 5-12

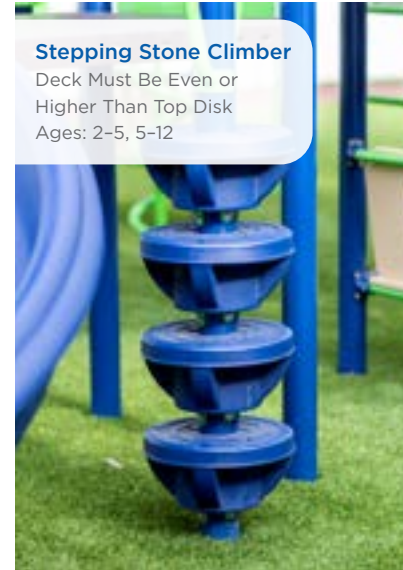

Stepping Stone Climber
Deck Must Be Even or Higher Than Top Disk
Ages: 2-5, 5-12

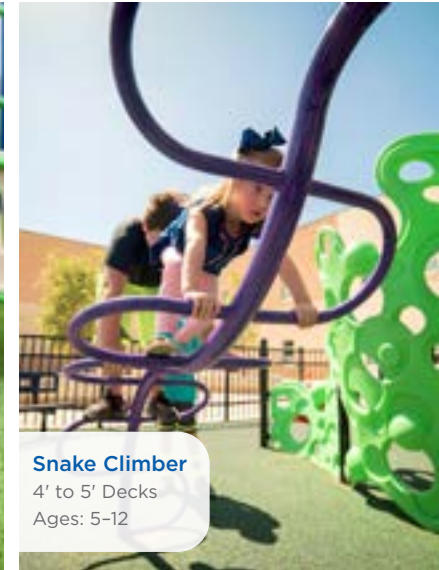

Snake Climber
4' to 5' Decks
Ages: 5-12

Bridges & Deck Connectors



Circular Net Bridge
Ages: 5-12
Decks: Equal Height Up to 4'
Length: 8'
Black Netting Only

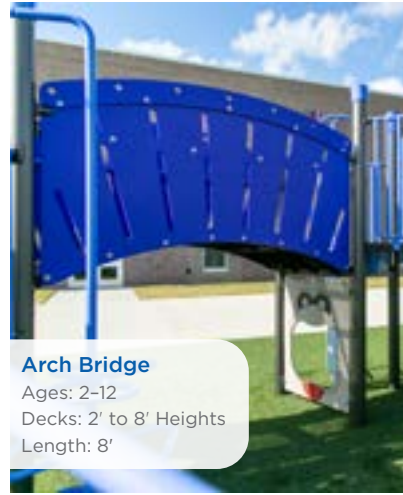

Arch Bridge
Ages: 2-12
Decks: 2' to 8' Heights
Length: 8'

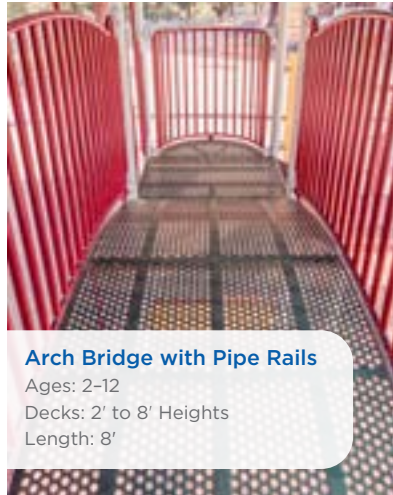

Arch Bridge with Pipe Rails
Ages: 2-12
Decks: 2' to 8' Heights
Length: 8'



Deck-to-Deck Delta Arch Climber
Ages: 5-12
Decks: 2' to 6' of Equal Height
Length: 8' or 12'

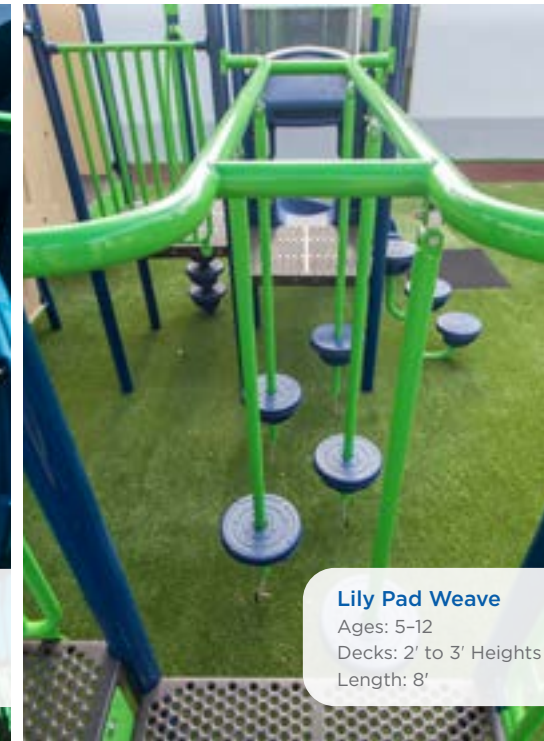

Lily Pad Weave
Ages: 5-12
Decks: 2' to 3' Heights
Length: 8'

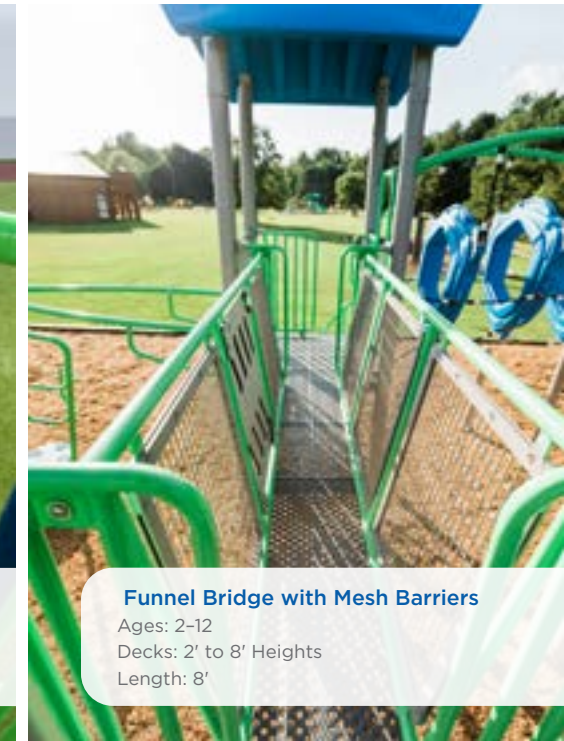

Funnel Bridge with Mesh Barriers
Ages: 2-12
Decks: 2' to 8' Heights
Length: 8'

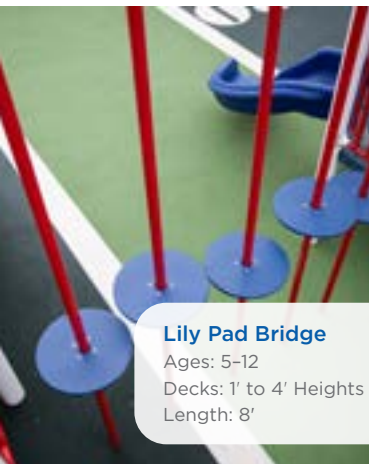

Lily Pad Bridge
Ages: 5-12
Decks: 1' to 4' Heights
Length: 8'

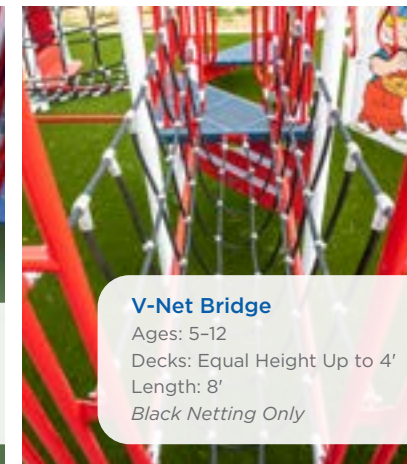

V-Net Bridge
Ages: 5-12
Decks: Equal Height Up to 4'
Length: 8'
Black Netting Only

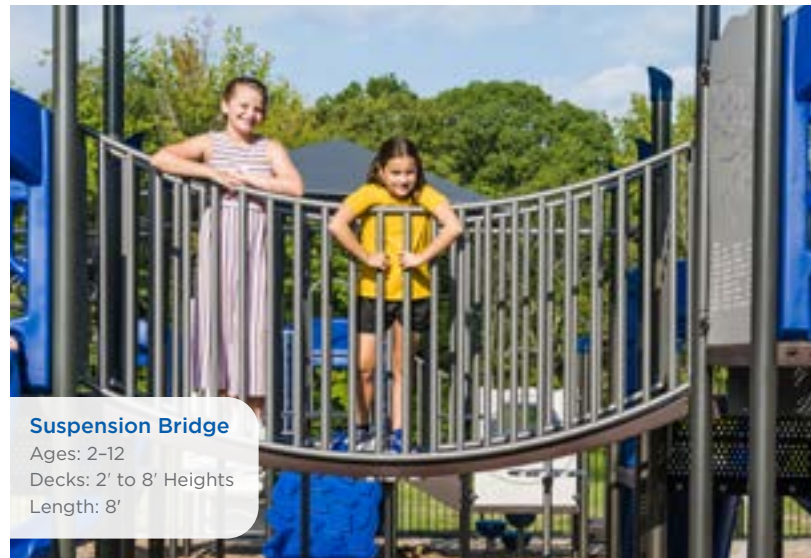

Suspension Bridge
Ages: 2-12
Decks: 2' to 8' Heights
Length: 8'

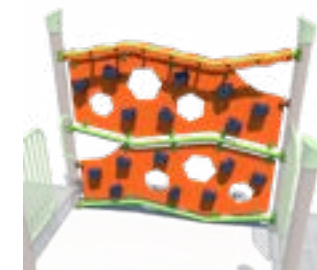

Rock Face Traverse Link
Ages: 5-12
Decks: Up to 2'
Length: 8'



Inclined 2' Bubble Tunnel
Ages: 2-12
Decks: Unequal Height
Length: 4'



Spiral Tetra Deck-to-Deck
Ages: 5-12
Decks: 1' to 4' Heights
Length: 8'



Challenge Bridge
Ages: 5-12
Decks: 2' to 2 1/2' Heights
Length: 8'

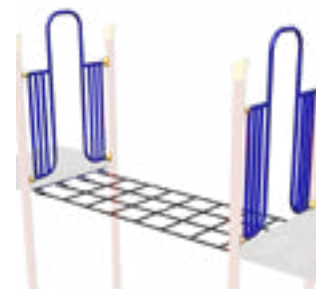

Cargo Net Bridge
Ages: 5-12
Decks: Max deck height is 4'. Can have transition decks up to 36".
Length: 8'
Black Netting Only

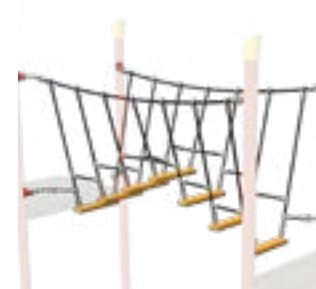

Catwalk Net Bridge
Ages: 5-12
Decks: Equal Height Up to 4'
Length: 8'
Black Netting Only



Vertical Spider Net Bridge
Ages: 5-12
Decks: Up to 4'
Black Netting Only

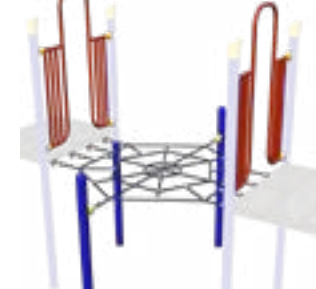

Hex Net Bridge
Ages: 5-12
Decks: Max deck height is 4'. Can have transition decks up to 36".
Length: 8'
Black Netting Only



Squiggle Walk Bridge
Ages: 5-12
Decks: 1' to 2 1/2' Heights
Length: 8'

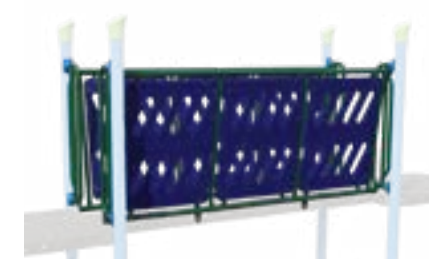

Funnel Bridge with HDPE Barriers
Ages: 2-12
Decks: 2' to 8' Heights
Length: 8'



Funnel Bridge with Mesh Barriers
Ages: 2-12
Decks: 2' to 8' Heights
Length: 8'

Bridges & Deck Connectors



Rockin' Glide
Ages: 2-5, 5-12
Capacity: 6 & One Mobility Device
Decks: 12", 18", and 24" Heights
Turning Space ADA Compliant per 304.3.1
Circular Space



Chain Link X Climber
Ages: 5-12
Decks: Unequal Height (36" and 48")
Length: 11'



90° Bridge
Ages: 2-12
Decks: 2' to 8' Heights

Active Components



Sonic Spinner
On-Deck & Post-to-Post Designs
Ages: 5-12



Snake Walk
Ages: 5-12
Length: 8'



Trapeze Ring
Arched, Inverted Arched, Curved
Ages: 5-12

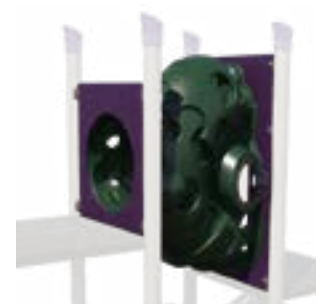

Inclined 2' Bubble Tunnel
Ages: 2-12
Decks: Unequal Height
Length: 4'



Arch Bridge Transition
Ages: 2-12
Decks: Unequal Height (1' Elevation)
Length: 4'

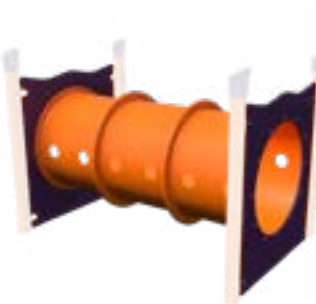

Straight Crawl Tunnel
4', 6', and 8' Lengths
Ages: 2-5, 5-12
Available for 5" Posts with 48" Decks
or 3.5" Posts with 46.5" Decks



Inclined Crawl Tunnel
12" and 24" Incline
Ages: 2-5, 5-12
Decks: Unequal Height
Available for 5" Posts with 48" Decks
or 3.5" Posts with 46.5" Decks

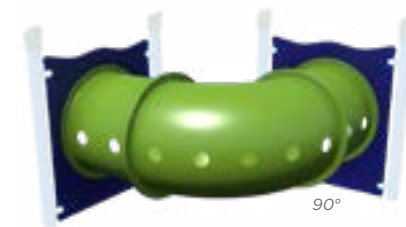

Curved Crawl Tunnel
60°, 90°, and 180° Curve Degrees
Ages: 2-5, 5-12
Available for 5" Posts with 48" Decks
or 3.5" Posts with 46.5" Decks

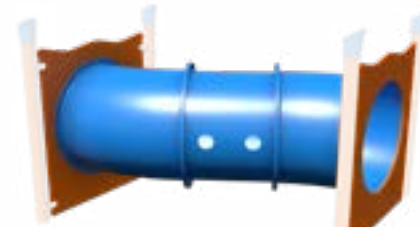

Zig-Zag Crawl Tunnel
Left or Right Zig-Zag
Ages: 2-5, 5-12
Decks: Equal Height Offset by 24"
Available for 5" Posts with 48" Decks
or 3.5" Posts with 46.5" Decks



Wavy Crawl Tunnel
Ages: 2-5, 5-12
Length: 8'
Available for 5" Posts with 48" Decks
or 3.5" Posts with 46.5" Decks



Curved Wheel Swinger
Ages: 5-12



Curved Corner Trapeze Ring
Ages: 5-12



Rail Glide
Ages: 5-12



Climbing Wall
Straight, Curved
Ages: 5-12

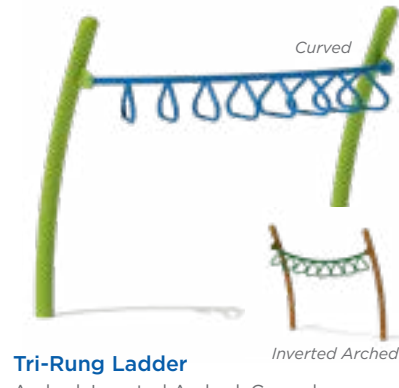

Tri-Rung Ladder
Arched, Inverted Arched, Curved
Ages: 5-12

Overhead Events



Tri-Rung
Straight, Zig-Zag, Wavy, 90°,
Arched
8' or 12' (Straight Only) Length
Ages: 5-12

Rung
Straight, Zig-Zag, Wavy, 90°,
Arched
8' or 12' (Straight Only) Length
Ages: 5-12

Offset Straight Rung
14' Length
Ages: 5-12

Track Glide
10' or 12' Length
Ages: 5-12



Single & Double Trapeze Ring
Straight and 90° (Single Only)
8' Length
Ages: 5-12

Single & Double Arched Trapeze Ring
12' Length
Ages: 5-12

Single & Double Parallel Bar
8' Length
Ages: 5-12



Loop Rung
Straight, 90°
8' Length
Ages: 5-12

Wavy Deep Rung
8' Length
Ages: 5-12

3-Wheel Swinger
8' Length
Ages: 5-12



270° Circle Ring
Ages: 5-12

360° Orbital
8' Length
Ages: 5-12

Over Under
8' Length
Ages: 5-12

Slides



Spiral Tube Slide
6' to 8' Deck Heights
Ages: 5-12
Available for 5" Posts with 48" Decks
or 3.5" Posts with 46.5" Decks



Single Chute Slide
2' to 8' Deck Heights
Multiple Configs.
Ages: 2-5, 5-12



90° Curve Slide
3' Deck Height
Ages: 2-5, 5-12



Straight Slide
4', 5', and 8' Deck Heights
Ages: 2-5, 5-12



Wave Slide
3' and 6' Deck Heights
Ages: 2-5, 5-12

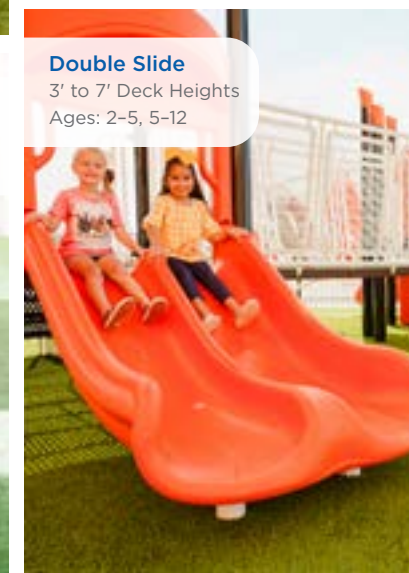

Double Slide
3' to 7' Deck Heights
Ages: 2-5, 5-12

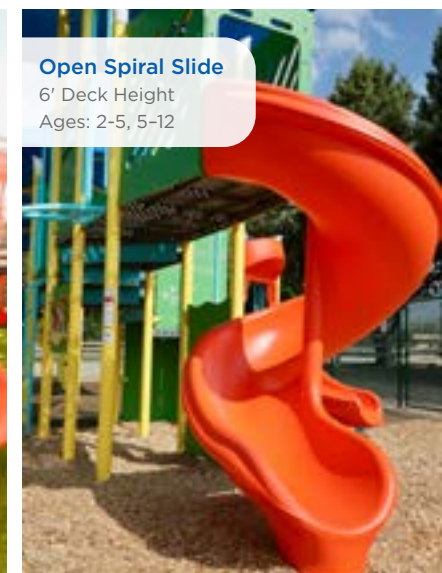

Open Spiral Slide
6' Deck Height
Ages: 2-5, 5-12

Slides



Curve Slide
Left Config.:
4' Deck Height
Right Config.:
4' & 5' Deck Heights
Ages: 2-5, 5-12

5' Double Curve Slide Also Available



Tri-Chute Slide
4' to 8' Deck Heights
Multiple Configs.
Ages: 2-5, 5-12



Spiral Chute Slide
8' Deck Height
Ages: 5-12



Snake Chute Slide
6' to 8' Deck Heights
Left and Right Config.
Ages: 5-12



Double Entry Chute Slide
4' to 8' Deck Heights
Multiple Configs.
Ages: 2-5, 5-12



Over & Under Chute Slide
8' Deck Height
Multiple Configs.
Ages: 5-12



Straight Tube Slide
2' to 8' Deck Heights
Ages: 2-5, 5-12



90° Turn Tube Slide
2' to 8' Deck Heights
Left and Right Configs.
Ages: 2-5, 5-12

*Available for 5" Posts with 48" Decks
or 3.5" Posts with 46.5" Decks*



Zig-Zag Tube Slide
4' to 8' Deck Heights
Left and Right Configs.
Ages: 2-5, 5-12

*Available for 5" Posts with 48" Decks
or 3.5" Posts with 46.5" Decks*



Tube-to-Chute Slide
8' to 14' Deck Heights
Left and Right Configs.
Ages: 2-5, 5-12



Triple Bedway Slide
Decks: 5'
Ages: 2-12



Roller Slide
5' Deck Height
Ages: 2-12



Single Stainless Steel Slide
Decks: 3' to 8'
Ages: 2-5, 5-12



Double Stainless Steel Slide
Decks: 3' to 8'
Ages: 2-5, 5-12

Activity Panels

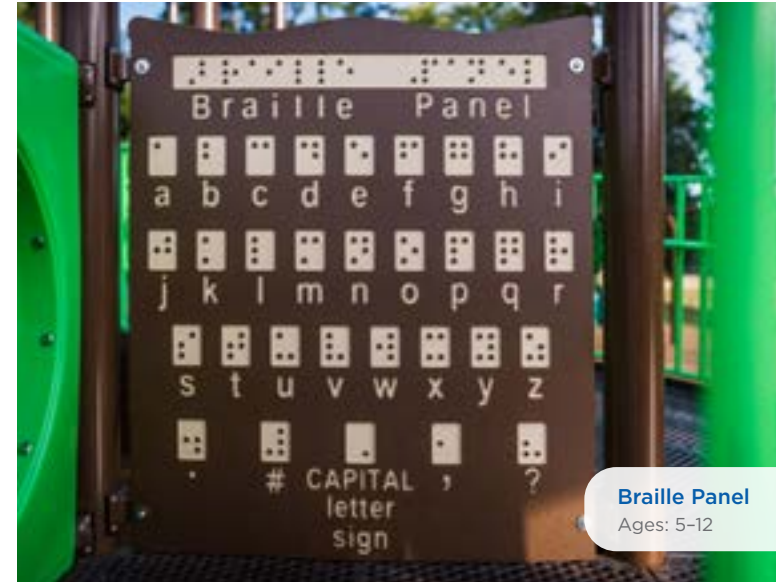

Braille Panel
Ages: 5-12

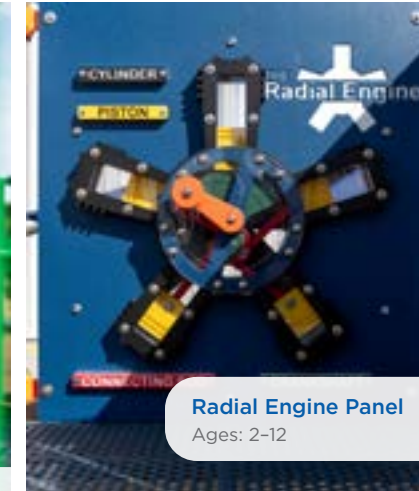

Radial Engine Panel
Ages: 2-12

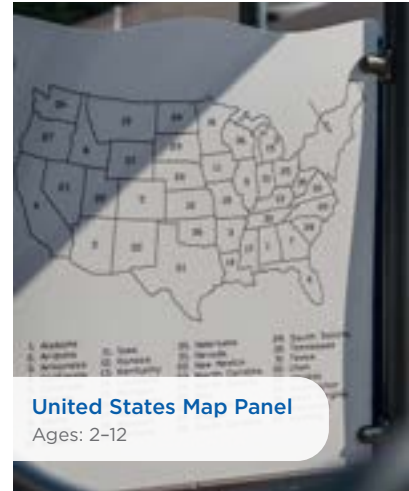

United States Map Panel
Ages: 2-12

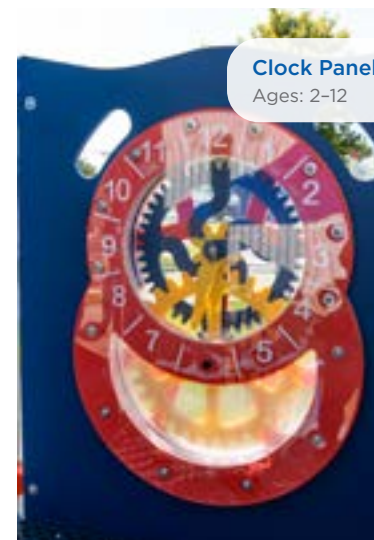

Clock Panel
Ages: 2-12

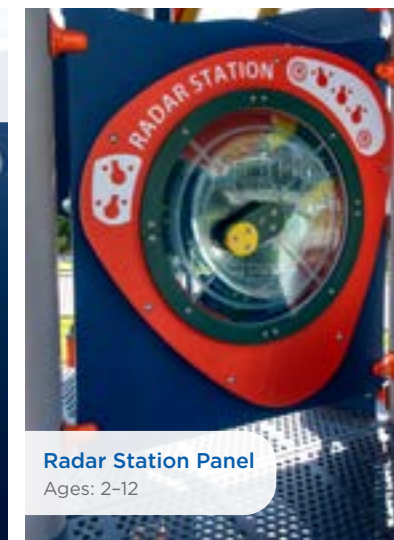

Radar Station Panel
Ages: 2-12



Monster Hide & Seek
Ages: 2-12



Frog Crawl Through Panel
Ages: 2-12
Ground-Level Only

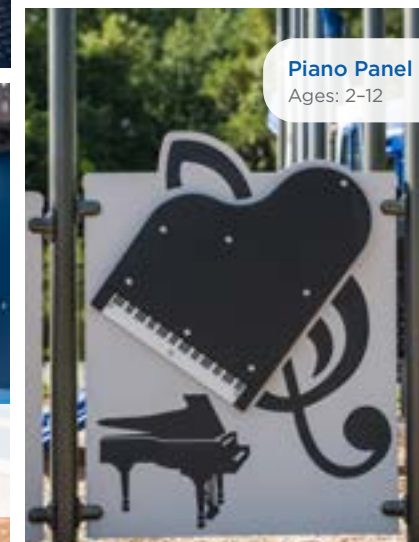

Piano Panel
Ages: 2-12

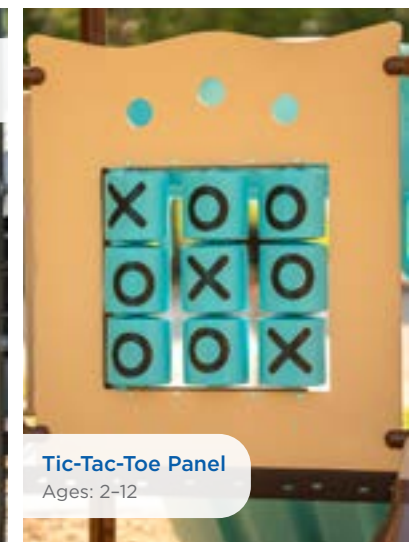

Tic-Tac-Toe Panel
Ages: 2-12

Activity Panels

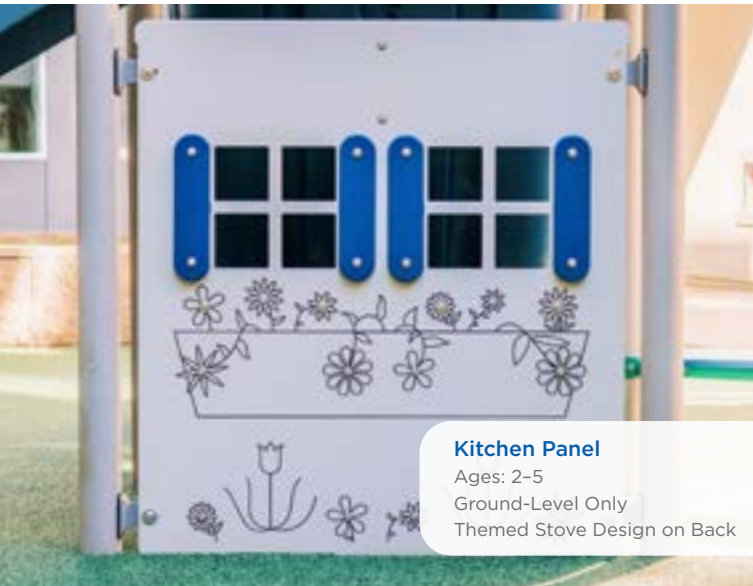

Kitchen Panel
Ages: 2-5
Ground-Level Only
Themed Stove Design on Back



Half Maze Panel
Ages: 2-12
Ground-Level Only



Window with Seat Panel
Ages: 2-5
Ground-Level Recommended



Clock/Sign Language Panel
Ages: 2-12
Interactive Clock Design on Back

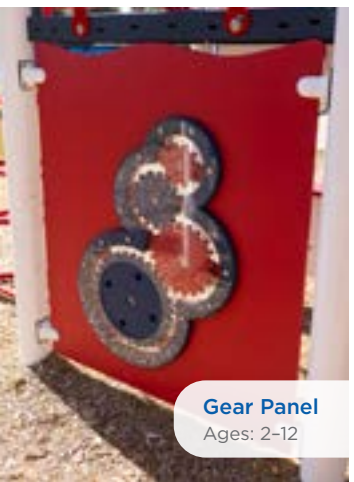

Gear Panel
Ages: 2-12

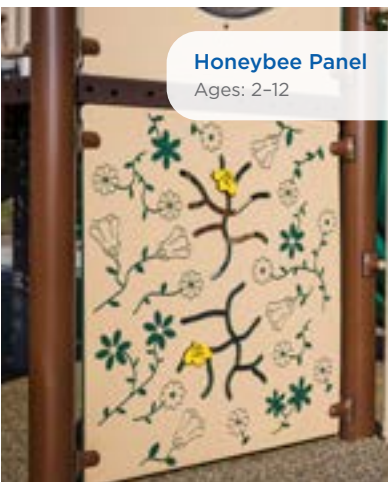

Honeybee Panel
Ages: 2-12

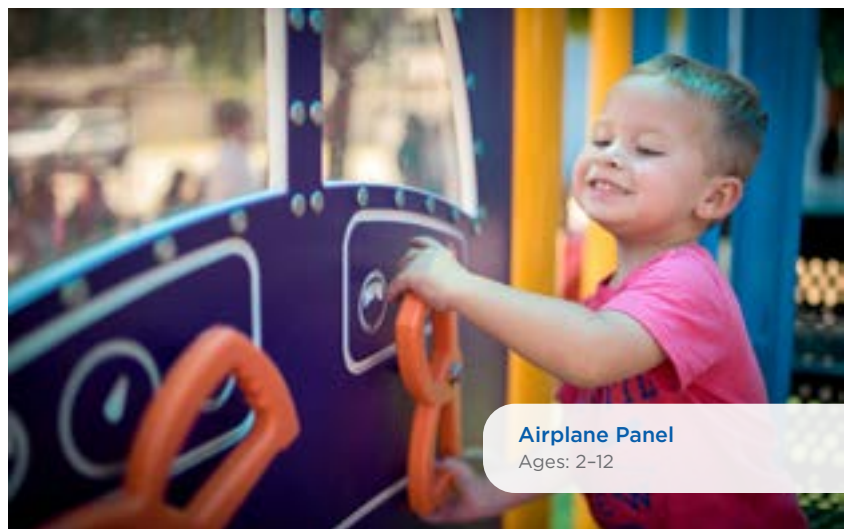

Airplane Panel
Ages: 2-12

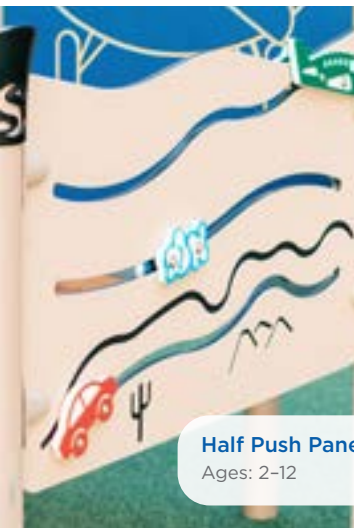

Half Push Panel
Ages: 2-12

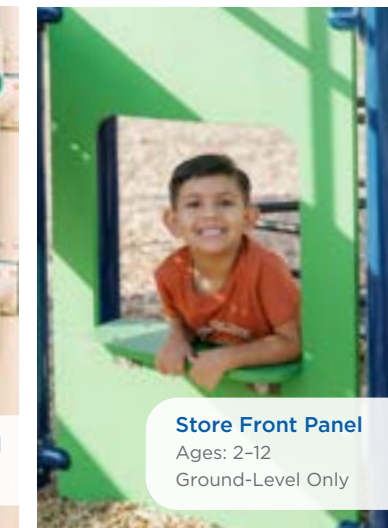

Store Front Panel
Ages: 2-12
Ground-Level Only



Solar System Panel
Ages: 2-12
Interactive Design on Back

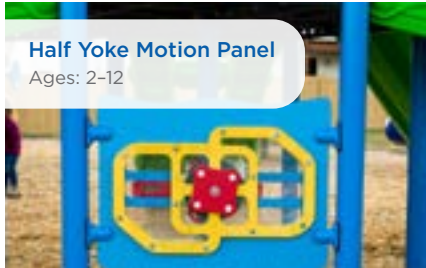

Half Yoke Motion Panel
Ages: 2-12

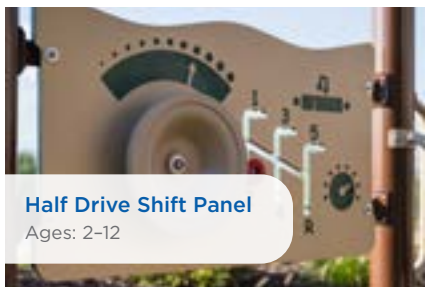

Half Drive Shift Panel
Ages: 2-12

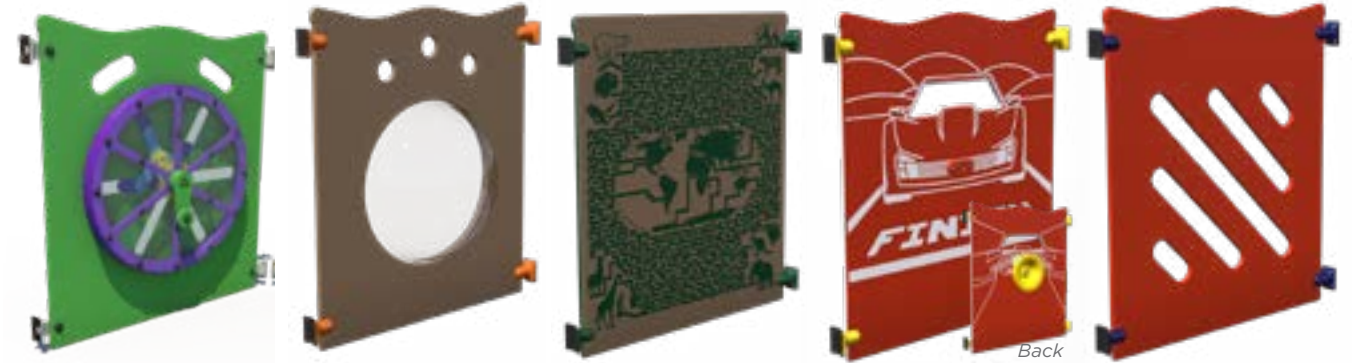

Tri-Yoke Panel Ages: 2-12
Bubble Panel Ages: 2-12
Animal Maze Panel Ages: 5-12
Race Car Panel Ages: 2-12
Slotted Panel Ages: 2-12



Starburst Panel Ages: 2-12
Window Panel Ages: 2-5
Ground-Level Recommended
Crawl Through Panel Ages: 2-12
Ground-Level Only
Driving Panel Ages: 2-12
Geo Panel Ages: 2-5



Alpha Panel Ages: 2-5
English to Spanish Panel Ages: 2-12
State Panel Ages: 2-12
Available for All States
Puppet Ages: 2-12
Toucan Panel Ages: 2-12



Butterfly Panel Ages: 2-12
Ball Toss Panel Ages: 2-12
Ground-Level Only
Spaceship Panel Ages: 2-12
Half Gear Panel Ages: 2-12
Ground-Level Only
Iris Panel Ages: 2-12

Activity Panels

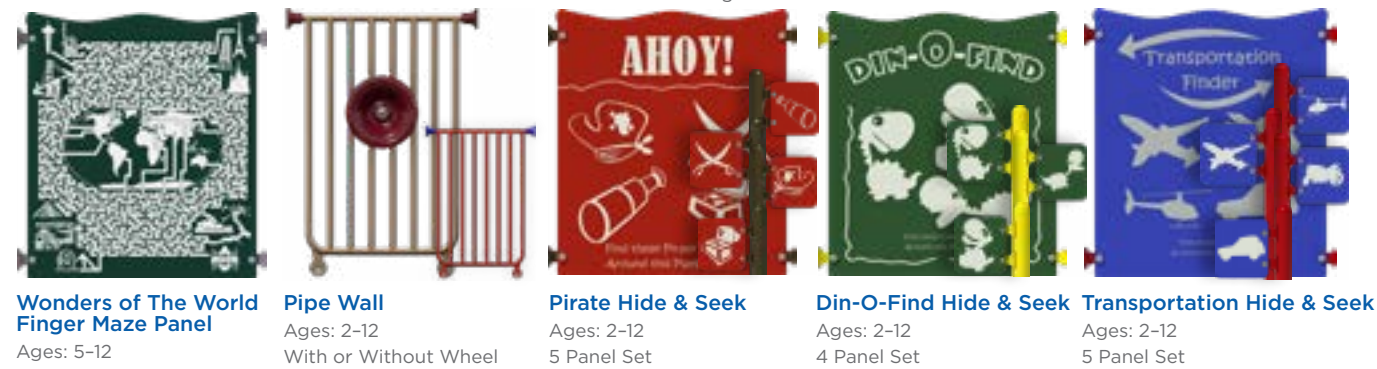
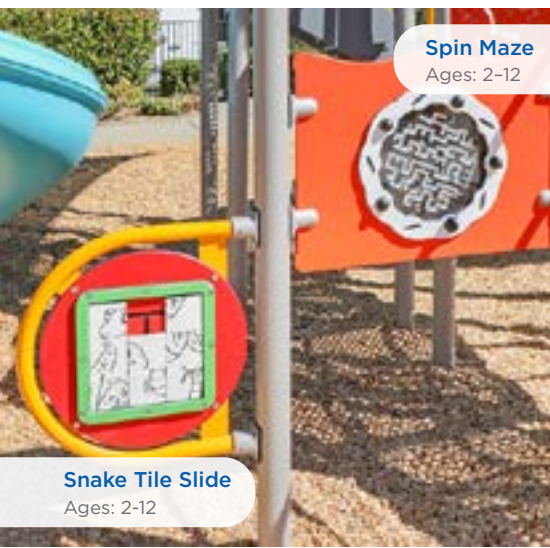

Panel Accessories & Decks

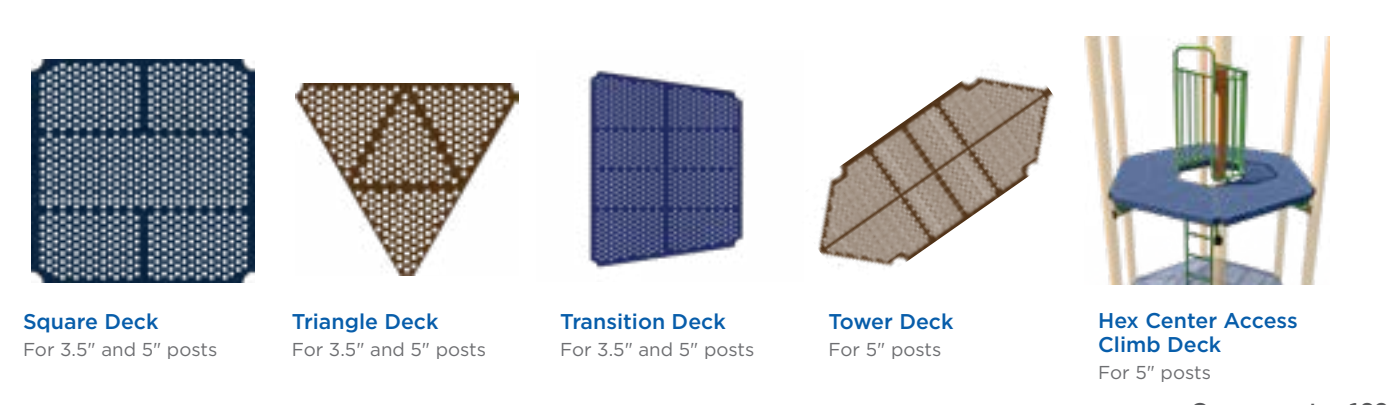
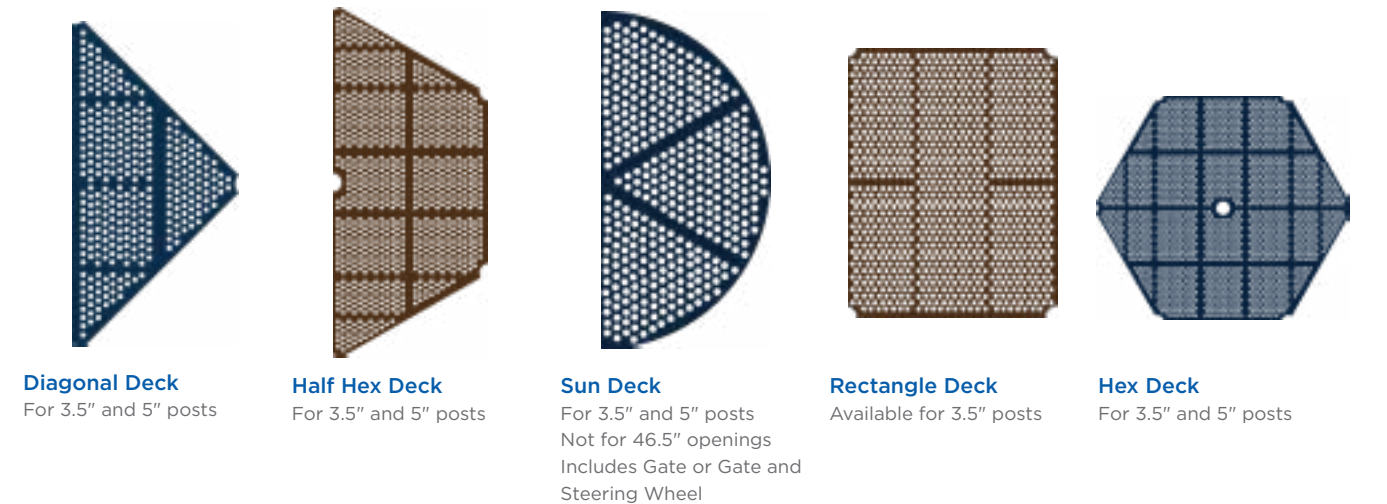
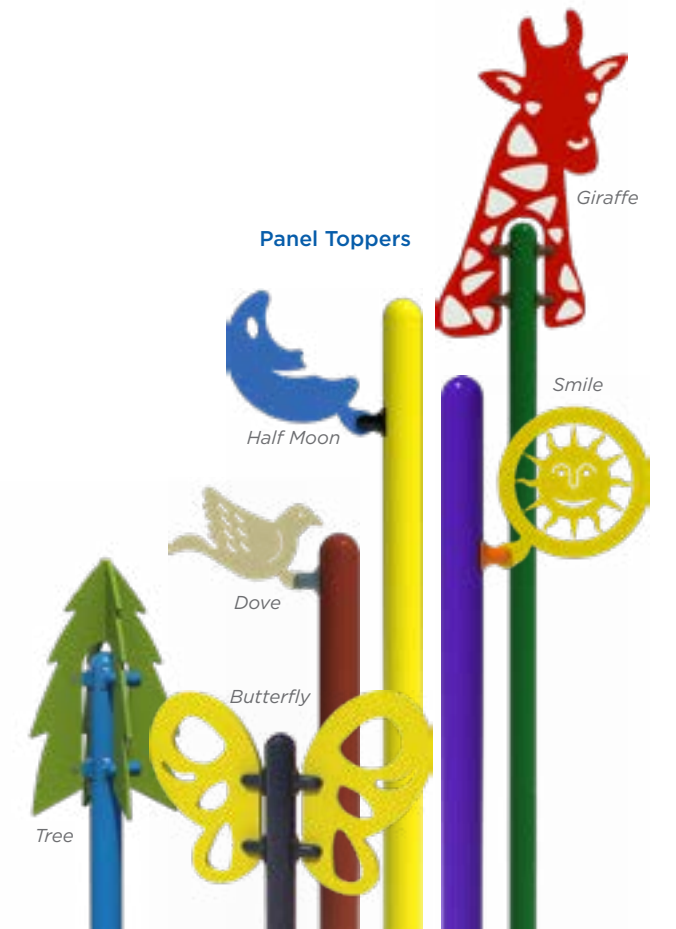
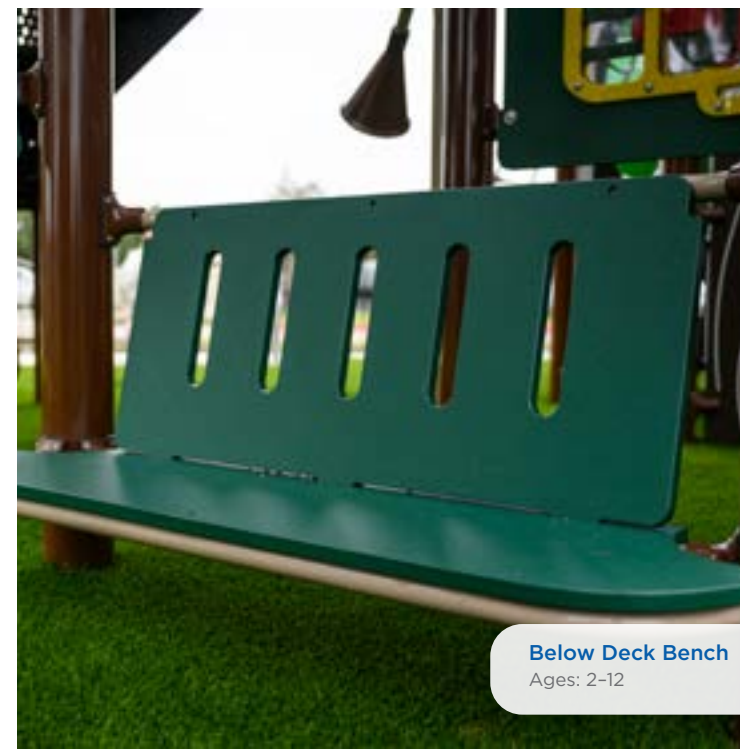

Ramps & Stairs



Sensory Ramp
Available for 5" Posts Only
4' x 12'
Available Activities:
• Duo Musical Instrument
• Solo Musical Instrument
• Ball Maze
• Kaleidoscope
• Pond & Flower Explorer
• Frog Slide Tile
• 4 in a Row

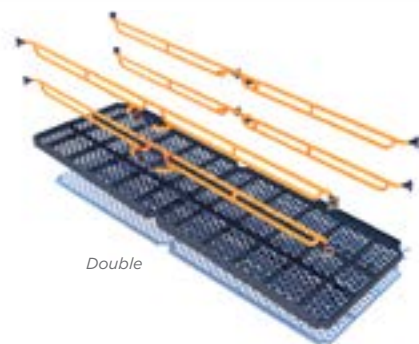

ADA Ramp with Handrails
Available for 5" Posts Only
6' or 12' Length
Single or Double Width Available



ADA Ramp with Barriers
Available for 5" Posts Only
6' or 12' Length
Single or Double Width Available



Traverse Ramp
Available for 5" posts
6' or 12' length
Single Width Available



ADA Transition Station
3' and 4' Deck Heights
Left and Right Configs.



Ground-to-Deck Stairs
2' to 6' and 8' Deck Heights



Single Step
12" to 16" Deck Heights
Available With or Without Handles



Deck-to-Deck ADA Transition Stair
12", 16", 24", 32", or 36" Elevation Change



Deck-to-Deck Transition Stair
21" and 33" Incline

Roofs



Arched Hexagon Roof
For Hexagon Decks



Arched Gable Roof
For Square and Rectangle Decks



Shingle Square Roof
For Square and Rectangle Decks



Ridge Square Roof
For Square and Rectangle Decks



Shingle Gable Roof
For Square and Rectangle Decks



Ridge Gable Roof
For Square and Rectangle Decks



Shingle Hexagon Roof
For Hexagon Decks



Arched Split Roof
For Square Decks



Eclipse Roof
Side Accent Color Panel Available



Octagon Metal Roof
For Octagon Decks

Modular Shades

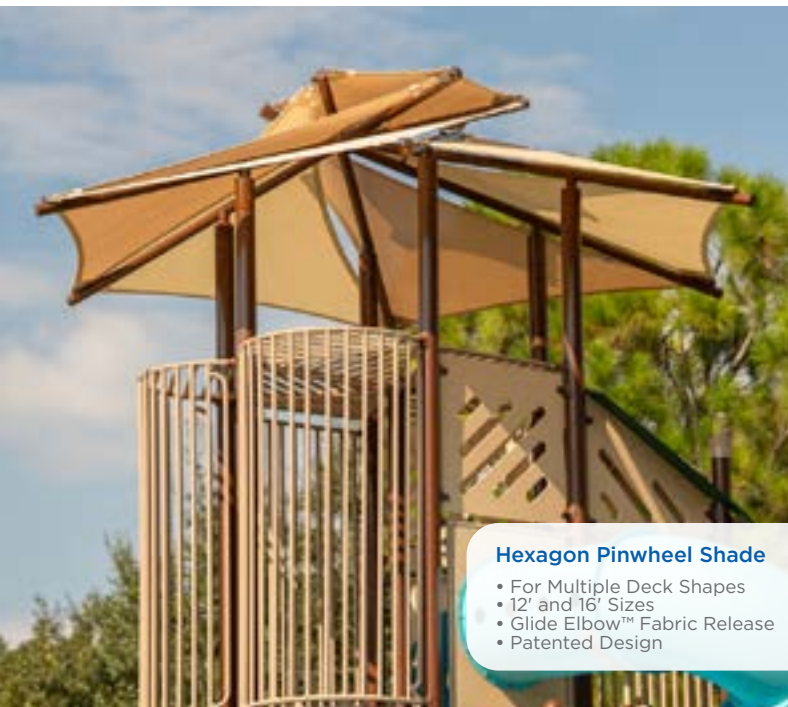

Hexagon Pinwheel Shade

- For Multiple Deck Shapes
- 12' and 16' Sizes
- Glide Elbow™ Fabric Release
- Patented Design



Square Pinwheel Shade

- For Square Decks
- 12' and 14' Sizes
- Glide Elbow™ Fabric Release
- Patented Design

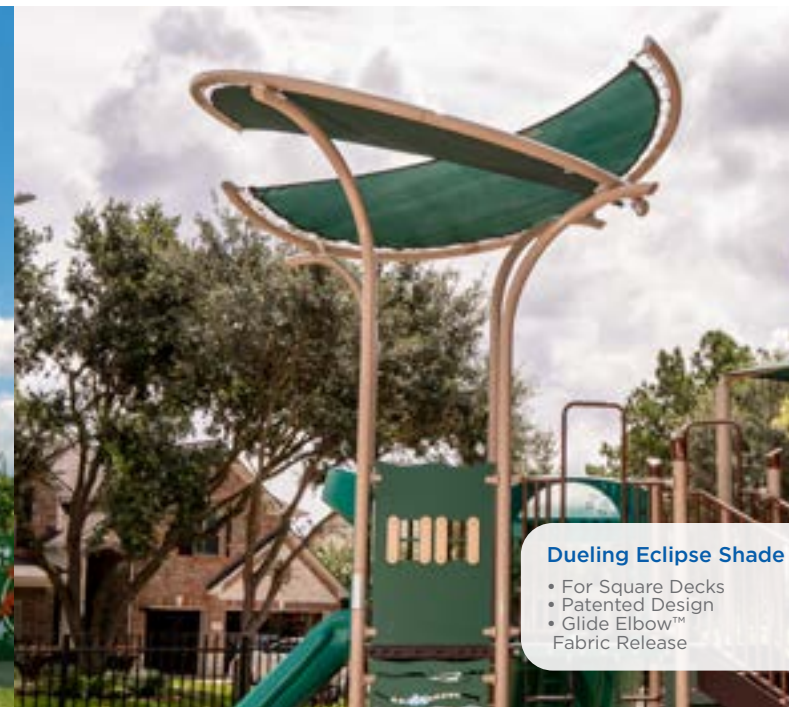

Dueling Eclipse Shade

- For Square Decks
- Patented Design
- Glide Elbow™ Fabric Release



Barrel Vaulted Shade

- For Square Decks
- Single Deck or Deck-to-Deck Config.

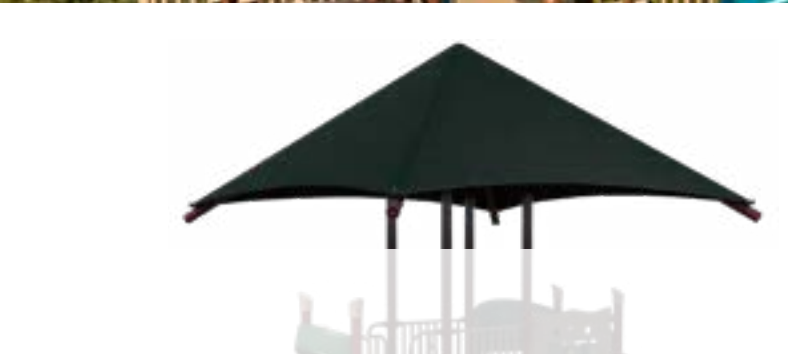

Square Shade

- For Square Decks
- 12' Size
- Glide Elbow™ Fabric Release



Rectangle Shade

- For Rectangle Decks
- Multiple Sizes
- For 3.5" Diameter Posts
- Glide Elbow™ Fabric Release



Quad Sail Shade

- For Square Decks
- Multiple Sizes
- Glide Elbow™ Fabric Release



New!

Crossover Sail Shade

- For Square Decks
- 14' x 14'
- For 5" Diameter Posts
- Glide Elbow™ Fabric Release



Hexagon Shade

- Varying Sizes
- For 5" Diameter Posts
- Glide Elbow™ Fabric Release



Octagon Shade

- For Triangle Decks Forming an Octagon
- 14' 4" Size
- For 5" Diameter Posts
- Glide Elbow™ Fabric Release



Crescent Shade

- 7' 4" x 5' 3" Size



New!

Umbra Shade

- For Square Decks
- 15' x 15'
- For 5" Diameter Posts
- Glide Elbow™ Fabric Release



Complete Your Space

- 176 Surfacing, Timbers, & Safety Signs
- 178 Fitness
- 182 Dog Park
- 186 Shade, Shelter, & Site Amenities

Top 6

Safety Surfacing Types

Unitary Options

1

Poured In Place (PIP)

- Two-layer system
- High wear resistance
- Lower maintenance
- Great accessibility
- Add graphics and mix colors

2

Bonded Rubber

- Made from recycled shredded rubber
- Great accessibility
- Medium wear resistance
- Many color options

3

Rubber Tiles

- Easy to repair
- Highly accessible
- High wear resistance
- Lower maintenance

4

Turf

- Looks like natural grass
- Impact layer and wear layer
- Medium wear resistance
- Low maintenance

Loose Fill Options

5

Loose Fill Rubber

- Made from recycled shredded rubber
- High wear resistance
- High impact attenuation rating
- Mold, animal, and insect resistant

6

Engineered Wood Fiber

- Economical initial cost
- Specifically for playgrounds
- Requires regular maintenance
- Use of wear mats recommended



Poured In Place (PIP)



Bonded Rubber



Rubber Tiles



Turf



Loose Fill Rubber

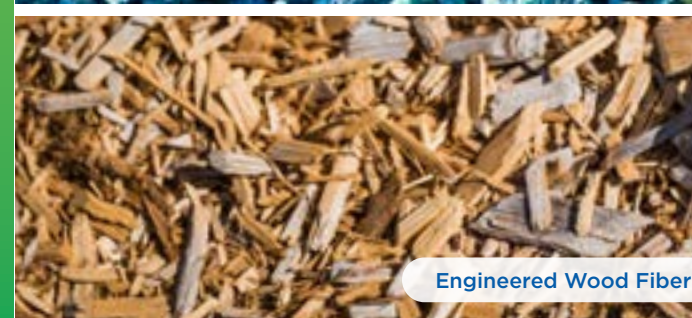

Engineered Wood Fiber



12" Landscape Timber

Order These If You're Purchasing a Steel Playground
These steel playground kit options include one timber and stake(s). The 4' option includes 1 stake and the 6' option includes two stakes.

Length	Item Number
4'	90022004XX
6'	90022006XX
Border Cap	BMP-0002XX

Order These If You're Purchasing a Recycled Playground
Each item must be purchased separately.

Length	Item Number
4'	LT-4
6'	LT-6
Border Cap	BMP-0002XX
Timber Stake	LTH



4' x 8" Landscape Timber

Order This If You're Purchasing a Steel Playground
Model: TFR0634XX
Includes Timber and Timber Stake

Order These If You're Purchasing a Recycled Playground
Timber Model: LT-4-8
Stake Model: LTH

ADA Accessible Ramp System

Our ADA ramp systems allow for easier transitions into your timber-bordered play environment. Designed for timbers that are 12" high.



Order These If You're Purchasing a Steel Playground

System	Item Number	Dimensions	Also Includes
Full	TFR0592XX	120" x 43"	9 Stakes, 2 End Caps
Half	TFR0591XX	60" x 43"	6 Stakes, 2 End Caps

Order These If You're Purchasing a Recycled Playground

System	Item Number	Dimensions	Also Includes
Full	TCF0078XX	120" x 43"	9 Stakes, 2 End Caps
Half	TCF0077XX	60" x 43"	6 Stakes, 2 End Caps

Age Safety Signs

23 1/2" x 15 1/2"

2-5: TFR19771XX

2-12: TFR19772XX

5-12: TFR19773XX



Fitness Equipment

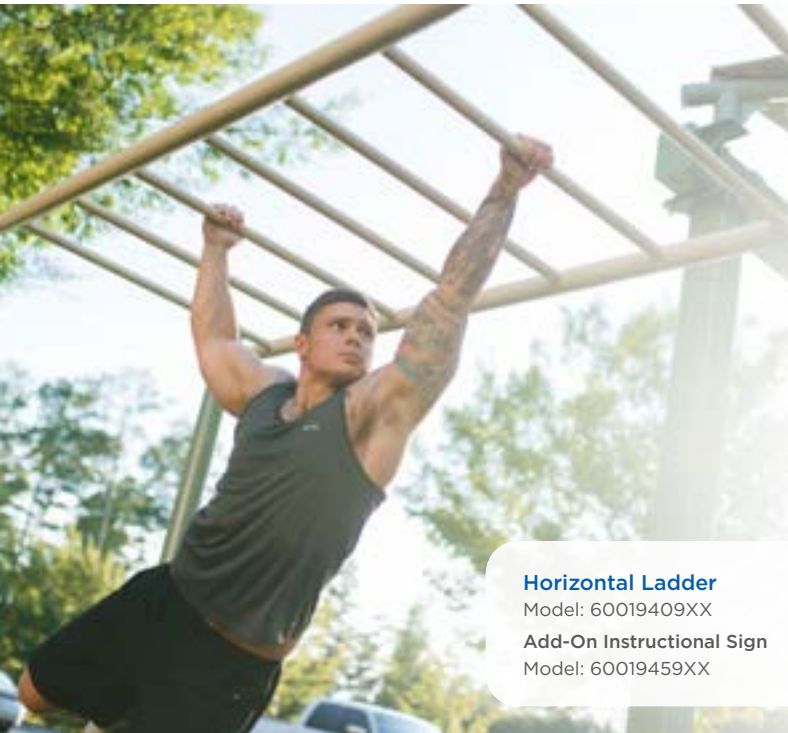

Horizontal Ladder
Model: 60019409XX
Add-On Instructional Sign
Model: 60019459XX

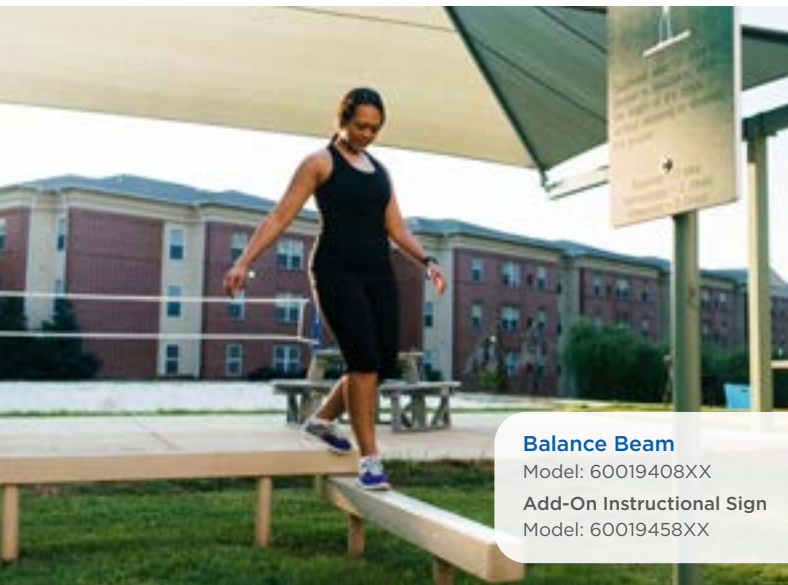

Balance Beam
Model: 60019408XX
Add-On Instructional Sign
Model: 60019458XX

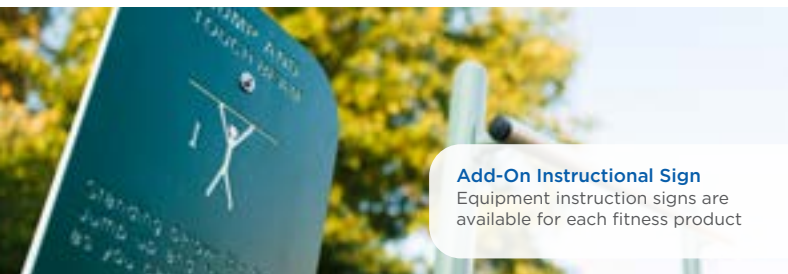

Add-On Instructional Sign
Equipment instruction signs are available for each fitness product



Vertical Ladder
Model: 60019402XX
Add-On Instructional Sign
Model: 60019452XX

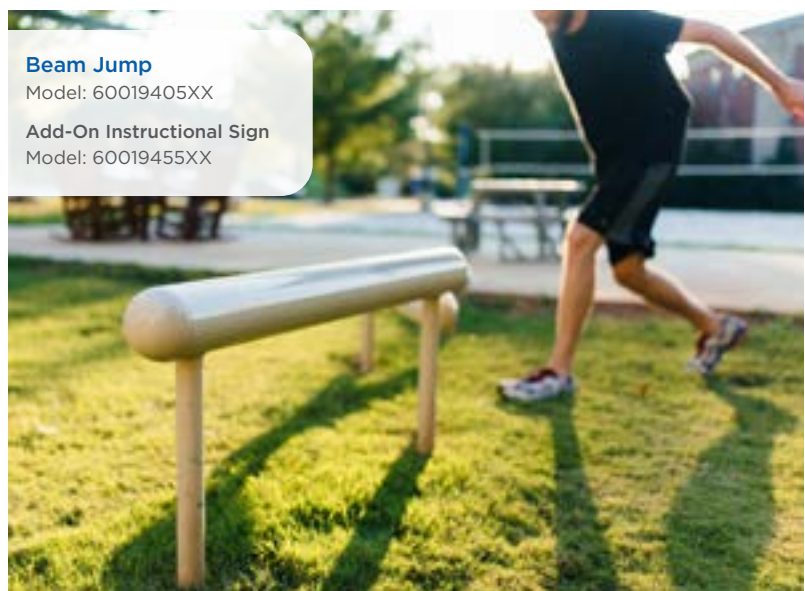

Beam Jump
Model: 60019405XX
Add-On Instructional Sign
Model: 60019455XX



Pull Up and Chin Up Bar
Model: 60019403XX
Add-On Instructional Sign
Model: 60019453XX



Spring Up Bars
Model: 60019410XX
Add-On Instructional Sign
Model: 60019460XX



Pull-Up and Dip Station
Model: AFT14031XX
Add-On Instructional Sign
Model: TFR0588XX
In-Ground Kit Required: FIT14050XX



Jump Touch Beam
Model: 60019406XX
Add-On Instructional Sign
Model: 60019456XX

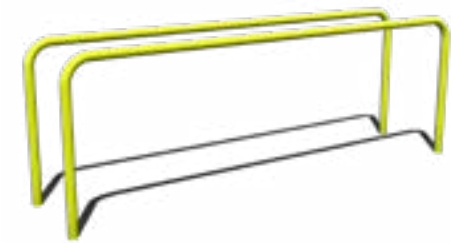

Parallel Bars
Model: 60019401XX
Add-On Instructional Sign
Model: 60019451XX



Stretching Post
Model: 60019404XX
Add-On Instructional Sign
Model: 60019454XX

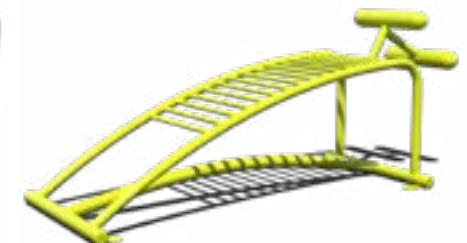

Sit-Up Bench
Model: AFT13972XX
Add-On Instructional Sign
Model: 60019457XX
In-Ground Kit Required: FIT14050XX

10 Station Fitness Course

Our 10 Station Fitness Course includes all the equipment seen here, plus three signs that have instructions for each piece of equipment.

Model: 60019400XX

- Vertical Ladder
- Beam Jump
- Stretching Post
- Pull Up and Chin Up Bars
- Jump Touch Beam
- Parallel Bars
- Sit-Up Bench
- Spring Up Bars
- Horizontal Ladder
- Balance Beam
- 3 Large Instructional Signs

Fitness Equipment

Instructional Sign with Post & Instructional Sticker

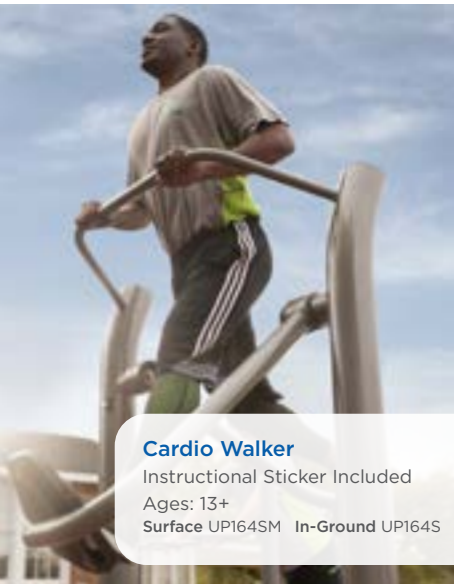

Cardio Walker
Instructional Sticker Included
Ages: 13+
Surface UP164SM In-Ground UP164S

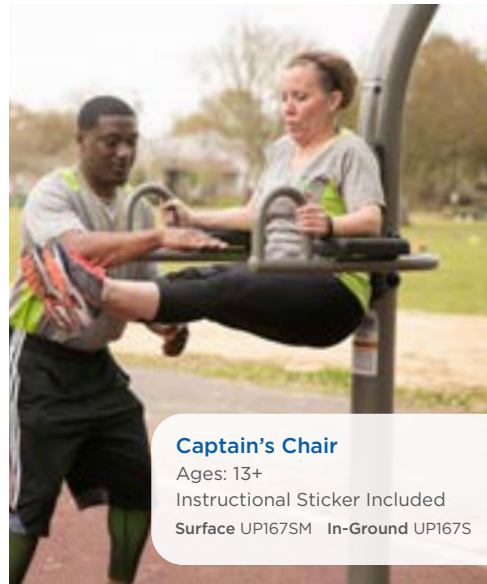

Captain's Chair
Ages: 13+
Instructional Sticker Included
Surface UP167SM In-Ground UP167S

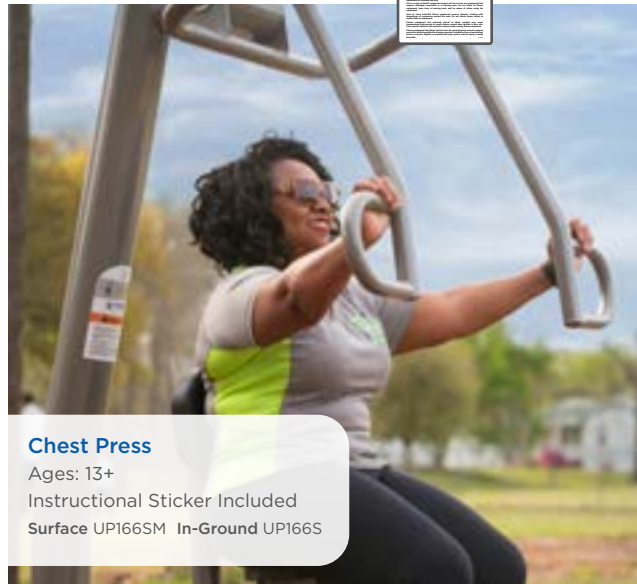

Chest Press
Ages: 13+
Instructional Sticker Included
Surface UP166SM In-Ground UP166S



Accessible Lat Pull Down
Ages: 13+
Instructional Sticker Included
Surface UP180SM In-Ground UP180S



Accessible ADA Chest Press
Ages: 13+
Instructional Sticker Included
Surface UP179SM In-Ground UP179S



Sit-Up/Back Extension
Ages: 13+
Instructional Sticker Included
Surface UP168SM In-Ground UP168S



Recumbent Cycle
Ages: 13+
Instructional Sticker Included
Surface UP215SM In-Ground UP215S



Plyometric Box
Ages: 13+
Instructional Sign Included
Heights Available:
6" Model: UP172 12" Model: UP173
18" Model: UP174 24" Model: UP175



Balance Plank Station
Model: UP176
Ages: 13+
Instructional Sign Included



Balance Board Station
Model: UP177
Ages: 13+
Instructional Sign Included



Push-Up Station
Model: UP224
Ages: 13+
Instructional Sticker Included



Hand Cycle
Ages: 13+
Instructional Sticker Included
Surface UP216SM In-Ground UP216S



Accessible ADA Hand Cycle
Ages: 13+
Instructional Sticker Included
Surface UP217SM In-Ground UP217S



Energy and Strength Wheels
Ages: 13+
Instructional Sticker Included
Surface UP191SM In-Ground UP191S

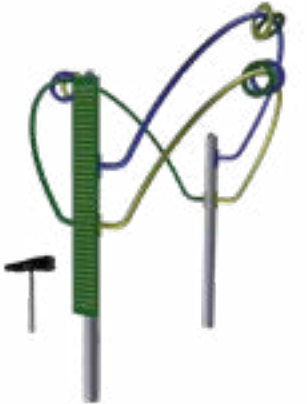

Skill Trainer
Model: UP354
Ages: 13+
Instructional Sticker Included



Horizontal Chin-Up Station
Model: UP183
Ages: 13+
Instructional Sign Included



Leg Press
Ages: 13+
Instructional Sticker Included



Lat Pull Down
Ages: 13+
Instructional Sticker Included
Surface UP165SM In-Ground UP165S



Assisted Balance Walk
Model: UP352
Ages: 13+
Instructional Sign Included



Assisted Step Trainer
Model: UP353
Ages: 13+
Instructional Sign Included



Assisted Step Around
Model: UP355
Ages: 13+
Instructional Sticker Included



Assisted Functional Trainer
Model: UP351
Ages: 13+
Instructional Sign Included

Dog Park Equipment



Over and Under
Model: RECF0012XX



Dog Log
Model: RECF0008XX



Home Sweet Home
Model: RECF0010XX

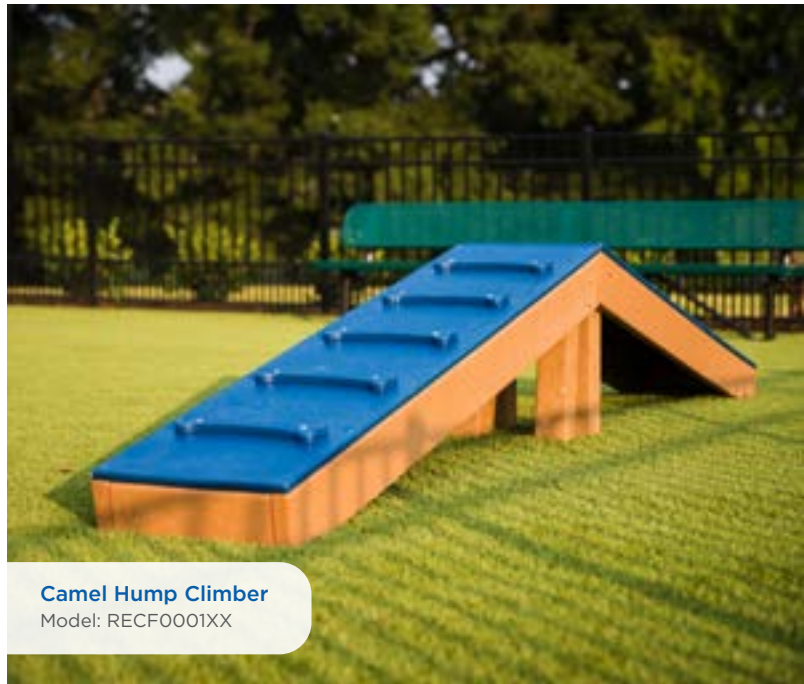

Camel Hump Climber
Model: RECF0001XX



Nice Turn
Model: RECF0013XX



Step Up
Model: RECF0005XX



Through the Target
Model: RECF0006XX



Climb and Sit
Model: RECF0002XX

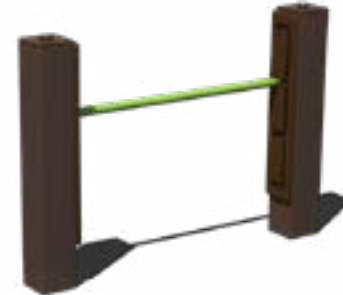

Limbone, Anyone?
Model: RECF0003XX



Hurdle Jump
Model: RECF0007XX
Sold as a set of 4



Through the Tunnel
Model: RECF0004XX

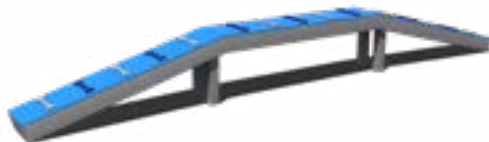

Walk the Plank
Model: RECF0015XX



Leash Holder
Model: RECF0022XX



Jump Through
Model: RECF0014XX



Let's Rest
Model: RECF0009XX



High Jump
Model: RECF0011XX

Dog Park Equipment Packages

Puppy Paradise

Model: RECF0018XX

Features:

- Beginner course
- Discounted package pricing
- 32' x 37' recommended area
- Package includes Jump Through, Stepping Up, Let's Rest, Camel Hump Climber, Home Sweet Home, and Nice Turn



Pawsitively Playful

Model: RECF0019XX

Features:

- Small area course
- Discounted package pricing
- 30' x 27' recommended area
- Package includes Jump Through, Stepping Up, Home Sweet Home, and Nice Turn



Dog's Best Friend

Model: RECF0017XX

Features:

- Intermediate course
- Discounted package pricing
- 28' x 33' recommended area
- Package includes Dog Log, Jump Through, Home Sweet Home, High Jump, Stepping Up, and Climb and Sit



Beggin' For More

Model: RECF0020XX

Features:

- Large area course
- 35' x 64' recommended area
- Package includes Camel Hump Climber, Through the Tunnel, Home Sweet Home, Dog Log, Jump Through, Let's Rest, Walk the Plank, High Jump, Stepping Up, and Over and Under



Master Companion

Model: RECF0016XX

Features:

- Advanced course
- Discounted package pricing
- 44' x 34' recommended area
- Package includes Through the Target, Dog Log, Walk the Plank, Limbone Anyone, Over and Under, and Home Sweet Home



Best in Show

Model: RECF0021XX

Features:

- Everything course
- 51' x 52' recommended area
- Package includes all dog play products except Hurdle Jump and Leash Holder



Complete *YOUR* Space

With Just One Company

Superior *Shade*

We offer shade structures for nearly every application. Shop our collection when looking for:

- Playground Shades
- Site Furnishing Shades
- Picnic Area Shades
- Bleacher Shades
- And More!

Visit srpshade.com to learn more.

Superior *Shelter*

We offer shelter structures that provide protection from both the weather and the sun. Shop our collection when looking for:

- Picnic Pavilions
- Bleacher Covers
- Wayfinding Kiosks
- And More!

Visit srpshelter.com to learn more.

Superior *Amenities*

We offer a full line of benches, tables, and trash receptacles in a variety of styles. Shop our collection when looking for:

- Tables
- Benches
- Trash Receptacles
- Bike Racks
- And More!

Visit srpsiteamenities.com to learn more.



We Make It Easy to Buy

Ordering is as easy as contacting your local Superior sales representative. They'll answer any questions and provide up-to-date pricing and shipping information for our products. To start, visit srpplayground.com/find-a-rep to find your local representative's contact information. Superior also makes it easy for clients to buy by utilizing reputable national purchasing cooperatives.

State-Specific Opportunities



The NASPO ValuePoint Cooperative Purchasing Organization is available to all public agencies, institutes of higher education, political subdivisions, and, in some cases, non-profit organizations in states who have obtained a NASPO ValuePoint Participating Addendum. Currently, we have partnered with the following states under NASPO ValuePoint Master Agreement No.: PO-10700-00015854.

- California
- Iowa
- Kansas
- New Mexico
- Oregon
- South Carolina
- South Dakota
- Utah
- Washington
- And More!

For Businesses



Navitas Credit Corporation is a nationwide direct lender with a focus on small and medium sized businesses. Navitas provides capital in the form of leases and loans to assist businesses in acquiring the equipment and financing they need to grow and stay competitive.

For Government Entities



BuyBoard is an online purchasing cooperative that gives its members best pricing on products, equipment, and services that they use every day. Members save time and resources because the competitive procurement process has already been completed. BuyBoard's nationwide members include those in public schools, municipalities, county government, and all types of local government agencies and non-profits.



HGACBuy is a cooperative purchasing network available to local governments, state agencies, and certain non-profit corporations nationwide. All products offered by HGACBuy have been awarded through a public competitive process. To become a member of HGACBuy and to view products like ours, visit hgacbuy.org.



GSA Advantage! is an online cooperative purchasing program that provides access to thousands of products and services. State and local government entities can take advantage of this buying power to get you the best value and price.

For Everyone

Our Certified Partners have extensive knowledge and training in all Superior products. Find your closest representative by visiting srpplayground.com and clicking "Contact a Representative."

We Meet or Exceed Industry Standards

In our effort to provide safer, quality play products for children, our products meet or exceed the standards set forth by the below organizations. Additionally, we follow our own strict in-house standards and guidelines.



International Play Equipment Manufacturers Association™

In the interest of playground safety, the International Play Equipment Manufacturers Association (IPEMA™) provides a third-party certification service whereby a designated independent laboratory, TÜV SÜD America Inc., (TÜV), validates an equipment manufacturer's certification of conformance to the standards below.

- ASTM F1487-11, excluding sections 7.1.1, 10 and 12.6.1: Standard Consumer Safety Performance Specification for Playground Equipment for Public Use
- CAN/CSA-Z614-14, excluding clauses 9.8, 10, and 11: Children's Playspaces and Equipment

A list of current validated products may be viewed on their website at www.ipema.org. SRP is a member of this organization.



American Society for Testing and Materials

The American Society for Testing and Materials (ASTM) is an independent and world renowned developer of technical standards utilized in testing a multitude of products. ASTM developed F1487 Standard Consumer Safety Performance Specifications for Playground Equipment for Public Use. The current standard is F1487-11, published in 2011.



U.S. Consumer Product Safety Commission

The U.S. Consumer Product Safety Commission (CPSC) presents safety guidelines through the publication of their Public Playground Safety Handbook. This handbook promotes greater safety awareness among those who purchase, install, and maintain public playground equipment. The handbook can be viewed on the CPSC's website, cpsc.gov.



United States Access Board

The U.S. Access Board is a federal agency that promotes equality for people with disabilities. They've developed guidelines and standards for built environments, such as playgrounds.

ISO 9001 and ISO 14001

ISO industry certification processes are issued by International Organization for Standardization. ISO 9001 is used to measure manufacturing standards and to certify company compliance with quality management systems covering design, development, production, installation, inspection, and testing. ISO 4001, also known as the "Green Certification," specifies the requirements of an organization having an environmental management system (EMS). SRP's steel playground line is manufactured in an ISO 9001 and ISO 14001 certified facility.

PCI 4000

Certification by the Powder Coating Institute recognizes competency and processes in place to consistently produce high-quality powder coated products. PCI certification is the result of an extensive and rigorous audit process and SRP's steel playground manufacturing facility has this certification.

In-House Standards

At Superior, we only use quality playground materials. Our playgrounds are proudly made in the USA and are built to last.

To ensure the safest play for your children, we offer:

- Quality control inspection on all parts and shipments
- All products must pass inspection in our IPEMA Certified In-House Testing Facility
- In-house production of most products
- All products meet or exceed CPSC, ASTM, and ADA Safety Guidelines
- On-staff CPSI certified employees
- Local field factory trained installation technicians
- Direct connect component attachment system
- Products constructed from Allied's heavy-wall galvanized steel tubing, which is protected by Allied's patented Flo-Coat® process that uses triple-coat corrosion protection (zinc, conversion coating, and clear topcoat) to provide a smooth, shiny appearance that is unmatched in strength and durability

We Use Quality Playground Materials

Learn more about the materials we use in our playgrounds by visiting srpplayground.com/why-superior/materials.

Our Leading Warranty

Our warranty guarantees years of unlimited fun. **View our full warranty by visiting us online at srpplayground.com/warranty.**

Superior Recreational Products (SRP) warrants that its product will be free from defects in materials and workmanship as well as maintain structural integrity for the periods listed below from the date of invoice and once SRP has been paid in full. This warranty is in effect only if the product has been assembled and installed strictly in accordance with the setup instructions provided by SRP, good construction practices, and has been subjected only to normal use and exposure.

- Lifetime* Warranty on playground steel and recycled posts, all stainless steel hardware, c-line fittings, and aluminum post caps
- 20-Year Limited Warranty on steel Shade structures
- 15-Year Limited Warranty on playground pipes, rungs, loops and rails, roto-molded plastics, HDPE plastic sheets, punched steel decks, and recycled decks
- 10-Year Limited Warranty on shade fabric and Ascend Rope Climber cable breakage
- 5-Year Limited Warranty on powder coat and climber nets and cables
- 3-Year Limited Warranty on electronic play and Ascend Rope Climber flexible rubber belting
- 1-Year Limited warranty on moving parts, Shade cable, and materials not covered above

Limited Warranty: Structural Steel

SRP offers a "Lifetime Limited Warranty on structural steel frames against failure due to rust-through corrosion under normal environmental conditions. Should the parts need to be replaced under the warranty, SRP will manufacture and ship new replacement parts at no charge for the first ten years, thereafter pro-rated at 50% for the second ten years and 25% from there on. Workmanship is warranted for a period of five years. This steel warranty shall be void if damage to the steel is caused by the installer or from physical damage, damage by salt spray or sprinkler systems, contact with chemicals, chlorine, pollution, misuse, vandalism, or any act of God.

Limited Warranty: Powder Coat

Superior Recreational Products offers a 5-year Limited Warranty for standard powder coating and a 7-Year Limited Warranty for Corrosion Defense Package powder coating to the original purchaser. This Limited Warranty is for factory applied finish only. Damage occurring from shipping, erection, vandalism, accidents, or field modification is not covered in this limited warranty and will require field touch-up immediately and periodically thereafter. The owner must report any defect in powder coat at the time the installation is completed. Not covered by this Limited Warranty are acute angles, welds, and end plates.

The Limited Warranty for powder coating provides the following after a 5-year exposure period when applied according to the recommendations listed on the product's technical data sheet and appropriate surface preparation has been utilized.

- The coatings shall retain their original color with a ΔE of <7.5 units for high chroma colors (yellows, reds, oranges, etc.) and a ΔE of <5.0 units for low chroma colors, when tested in accordance with ASTM D 2244.
- The coating shall retain a minimum of 50% of its original gloss level after washing, when tested in accordance with ASTM D 523.
- The coating shall exhibit chalking no worse than numerical rating of 6, when evaluated in accordance with ASTM D 659-80.

Stainless Steel Series (Powered by Playdale Playgrounds)

Playdale Playgrounds warrants its products to the original customer to be free from structural failure due to defect in materials or workmanship during normal use and installation in accordance with the published specifications. The warranty shall commence on the date of the invoice and terminate at the end of the period on the full warranty statement. The warranty is valid only if the products are installed properly and in conformance of the specifications, installation guides, Playdale Playgrounds design layout, and properly maintained in accordance with the maintenance schedule provided within the installation instructions. Playdale Playgrounds reserves the right to accept or reject any claim in whole or in part. Playdale Playgrounds will not accept the return of any product without prior approval by Playdale management.

Electronic Play

SRP guarantees the speakers, sound chips, and circuit boards used in the production of their electronic play products for 3 years, against electronic failure caused by manufacturing defects. This guarantee does not include failure as a result of any form of misuse, vandalism or neglect including, but not limited to accidental damage while changing the batteries or servicing the internal electronics, a failure to follow the battery replacement guide, the troubleshooting guide or the care and maintenance instructions for the electronics units.

Pricing, Cancellation, Return, and Shipping Policies

All prices are F.O.B. factor and do not include freight, installation, shipping and handling, surfacing, or applicable taxes. All prices listed were current at the time of printing and in U.S. currency. Prices are subject to change without notice. To view our return policy, please visit superiorrecreationalproducts.com/returns. For information on Return Material Authorizations please call 1.800.327.8774. To view our shipping policy, please visit superiorrecreationalproducts.com/shipping. For any further information, please call 1.800.327.8774.

**For the purpose of this warranty, lifetime encompasses no specific term of years, but rather that seller warrants to its original customer for as long as the original customer owns the product and uses the product for its intended purpose that the product and all parts will be free from defects in materials and manufacturing workmanship. This warranty does not cover damage caused by vandalism, misuse or abuse, altered or modified parts, or cosmetic damage such as scratches, dents, or fading or weathering and normal wear and tear. This warranty is valid only if the structures are installed in conformity with instructions provided by Superior Recreational Products using approved Superior Recreational Products parts. Superior Recreational Products will deliver the repaired or replacement part or parts to the site free of charge, but will not be responsible for labor or the labor costs of replacement. Warranty claims must be filed within the applicable warranty period and accompanied by a sales order or invoice number.*

Color Options

Metal Colors

Gloss



Matte or Metallic



Plastic Colors



Activity Panel & Panel Colors

Solid Core



Sandwich Core



Shade Colors | More Available!



Steel Deck Colors



Recycled Deck & Post Colors



*May affect delivery lead time.

Ascend Rope Colors

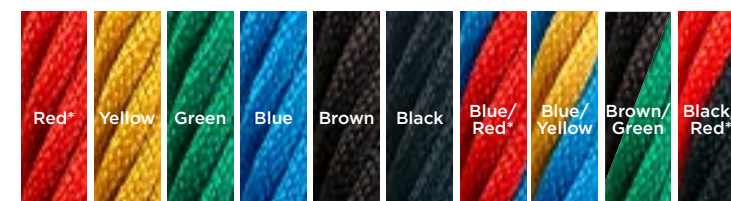

*Red rope fades naturally under prolonged sunlight.

Belt Seat Colors



Color Schemes



Nature Trail

- Brown
 - Spring Green
 - Orange
 - Beige
 - Beige
- Shade Color Recommendation



Northern Lights

- Champagne
- Ice Mint
- Starlight
- Blue
- Silver



Robin Egg

- Brown
- Beige
- Azure
- Cream



Circus

- Red
- Yellow
- Sky Blue
- Yellow



Spring Sprout

- Vanilla
- Spring Green
- Beige
- Rivergum



Electric

- Champagne
- Chartreuse
- White
- Blue
- Silver



Del Rio

- Vanilla
- Azure
- Beige
- Orange
- Beige



New! Americana

- Vanilla
- Blue
- Sky Blue
- Red
- True Blue



Terra

- Burgundy
- Beige
- Spring Green
- Beige



Van Gogh

- Metallic
- Bronze
- Champagne
- Periwinkle
- Steel Gray



Synthwave

- Champagne
- Ocean
- Royal Purple
- Chartreuse
- Royal Purple



Spring Bloom

- Sky Blue
- Spring Green
- White
- Orange
- Rivergum



Forest

- Burgundy
- Beige
- Green
- Beige



New! Macaw

- Champagne
- Yellow
- Sky Blue
- Orange
- Orange



Aqua Vista

- Metallic
- Butterscotch
- White
- Orange
- Azure
- Steel Gray



Spring Storm

- Champagne
- Spring Green
- Black
- Sky Blue
- Lime



Wisteria Garden

- Vanilla
- Sage
- Beige
- Royal Purple
- Cream



New! Orchid

- Vanilla
- Chartreuse
- Royal Purple
- Orange
- Orange



Pistachio

- Vanilla
- Chartreuse
- Beige
- Burgundy
- Lime



Oasis

- White
- Blue
- Orange
- Spring Green
- True Blue

Superior[®]

RECREATIONAL PRODUCTS

A PLAYCORE company

1050 Columbia Drive
Carrollton, GA 30117

866.699.4339

srplayground.com

