



PLAYGROUNDS & SITE AMENITIES

# Superior<sup>®</sup> *Amenities*

2025 Product Catalog



Outdoor Furniture • Dog Park Equipment • Outdoor Fitness Equipment



# Site Furnishings Ready For Your Community

We know that when a bench, table, or trash receptacle leaves us, it has to be ready to serve your community.

That's why at Superior Recreational Products we've built our company on hard work and the promise of providing you, our customer, with durable and reliable commercial outdoor furniture, dog park equipment, and fitness equipment at a great price. We combine quality materials and superior craftsmanship to provide you with products that are ready for whatever your community has in store.

## What's Inside

- 06 Basic Table & Bench Collection
- 10 Essentials Table Collection
- 24 Essentials Bench Collection
- 34 Essentials Accessory Collection
- 42 Early Childhood Collection
- 44 Recycled Collection
- 48 Uptown Collection
- 58 Aluminum Bleacher Collection
- 60 Dog Park Collection
- 68 Fitness Collection

### Our Bedrock, Your Benefits

-  Flagship offering made in America
-  Exclusive textured polyethylene coating that is durable and easily repaired
-  Low maintenance & vandal-resistant
-  Quality without the high price
-  Furniture, dog park equipment, and fitness equipment from one company

### Helping You Say Goodbye to Bidding

We've teamed with strategic partners so you can bypass the bidding process. Visit [srpsiteamenities.com/contracts](http://srpsiteamenities.com/contracts) to learn more.



### Ordering Made Easy

Contact your local Superior sales representative to start the ordering process. They can answer any questions and provide product pricing and shipping information. Find your local representative at [srpsiteamenities.com/find-a-rep](http://srpsiteamenities.com/find-a-rep).

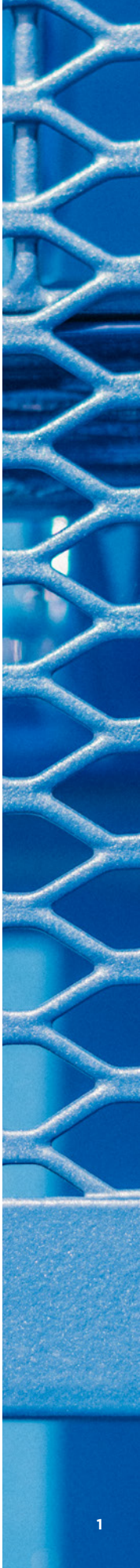

## What's New

**NEW!**  
Shaded Bike Parking  
PAGE 36

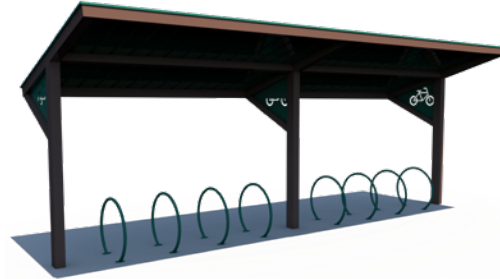

**NEW!**  
Choose from  
Two Finishes  
for Essentials  
Collection  
PAGE 72

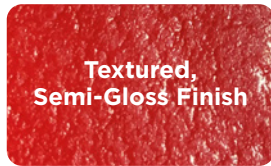

Textured,  
Semi-Gloss Finish



Smooth, Glossy  
Finish

## Quick Ship

### Your Order Shipped in 7-10 Business Days

We offer tables, benches, and trash receptacles that ship within 7-10 business days. Visit [srpsiteamenities.com/products/quick-ship](https://srpsiteamenities.com/products/quick-ship) to learn more.

 Look for our icon throughout the catalog to see qualifying products.

## Shopping Tools



### Sketchfab

Select table, bench, and trash receptacle models are available on [sketchfab.com](https://sketchfab.com).



### CADdetails

Select table, bench, and trash receptacle models are available on [CADdetails.com](https://CADdetails.com).



### Space Planning Tool

See how many picnic tables will fit in an area by visiting [srpsiteamenities.com/design-tools](https://srpsiteamenities.com/design-tools).



### Color Applier

View products in 360° and choose your colors by visiting [srpsiteamenities.com/design-tools](https://srpsiteamenities.com/design-tools).



## Customization



### Personalize Your Product

Most of our furnishings can be customized with logos, images, designs, and lettering. You can also incorporate a contrasting backing plate to enhance the visual impact of your design.



- Upcharge per customized piece
- Upcharge for powder coated backing plate
- Customization available on most products

Learn more at [srpsiteamenities.com/customization](https://srpsiteamenities.com/customization).

## Video Library



### Factory Tour

Take a tour of our manufacturing facility and meet the faces that bring your outdoor site furniture to life. Watch it at [srpsiteamenities.com/about-us](https://srpsiteamenities.com/about-us).



### Rainier Bench

### Product Videos

Learn details of our most popular benches, tables, and trash receptacles. Watch them on our YouTube channel: [youtube.com/c/SuperiorRecreationalProducts](https://youtube.com/c/SuperiorRecreationalProducts).

## Our Other Product Lines



### Superior *Shade*

Standard and custom shade structures for nearly every outdoor location. Learn more at [srpshade.com](https://srpshade.com).



### Superior *Shelter*

Durable steel shelters designed for use in a variety of outdoor settings. Learn more at [srpshelter.com](https://srpshelter.com).



### Superior *Playgrounds*

Commercial-grade playground structures and freestanding equipment. Learn more at [srpplayground.com](https://srpplayground.com).





## Basic Table & Bench COLLECTION

a practical line of thermoplastic coated tables, benches, and trash receptacles

07 Tables 08 Benches 09 Trash Receptacles

Qualifying Products Available for Quick Ship



### Basic Rectangular Portable Table

#### SPECIFICATIONS

- 2 3/8" black powder coated frame
- Glossy, thermoplastic table top and seats available in blue, red, green, and black
- Pre-drilled surface mount holes
- Replace (#) with length desired

	PRODUCT NO.	LENGTHS (#)
UltraLeisure®	T#UL	6', 8'



### Basic Accessible Rectangular Portable Table

#### SPECIFICATIONS

- 2 3/8" black powder coated frame
- 24" of overhang for ADA accessibility
- Glossy, thermoplastic table top and seats available in blue, red, green, and black
- Pre-drilled surface mount holes

	PRODUCT NO.	LENGTH
UltraLeisure®	T8ULHDCP	8'



### Basic Square Portable Table

#### SPECIFICATIONS

- 1 5/8" (economy) black powder coated frame
- 46" square table top featuring standard umbrella hole
- Glossy, thermoplastic table top and seats available in blue, red, green, and black
- Pre-drilled surface mount holes

	PRODUCT NO.	SEATS
UltraLeisure®	T46UL	3, 4



### Basic Accessible Square Portable Table

#### SPECIFICATIONS

- 1 5/8" (economy) black powder coated frame
- Glossy, thermoplastic table top and seats available in blue, red, green, and black
- Pre-drilled surface mount holes
- Extended 55" table top
- Features standard umbrella hole and 3 seats

	PRODUCT NO.
UltraLeisure®	T46UL-3





T46ULRACS

### Basic Round Portable Table

#### SPECIFICATIONS

- 1 5/8" (economy) black powder coated frame
- 46" round table top featuring standard umbrella hole
- Glossy, thermoplastic table top and seats available in blue, red, green, and black
- Pre-drilled surface mount holes

	PRODUCT NO.	SEATS
UltraLeisure®  	T46ULRACS	3, 4

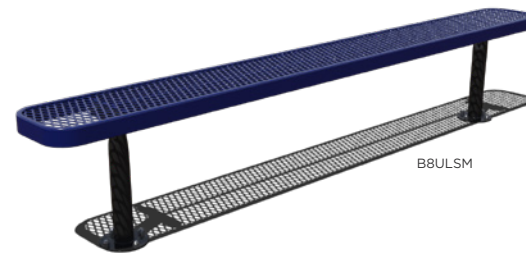

BBULSM

### Basic Standard Bench without Back

#### SPECIFICATIONS

- 2 3/8" black powder coated frame
- Add P (portable), SM (surface mount), or S (in-ground mount) to end of product number
- Glossy, thermoplastic seat available in blue, red, green, and black
- 10" seat width and 17" seat height

	PRODUCT NO.	LENGTHS (#)
UltraLeisure®  	B#UL	6', 8'





B6WBULSM

### Basic Standard Bench with Back

#### SPECIFICATIONS

- 2 3/8" black powder coated frame
- Add P (portable), SM (surface mount), or S (in-ground mount) to end of product number
- Glossy, thermoplastic back and seat available in blue, red, green, and black
- 10" seat width and 17" seat height

	PRODUCT NO.	LENGTHS (#)
UltraLeisure®  	B#WBUL	6', 8'



TR32UL

### Basic Trash Receptacle

#### SPECIFICATIONS

- 32 gallon capacity
- UltraLeisure® metal design
- Flat top lid and liner included
- Surface and in-ground mount options sold separately
- Glossy, thermoplastic coating
- Only available in black

PRODUCT NO.: TR32UL





## Essentials Table COLLECTION

a traditional line of coated outdoor tables  
suitable for every outdoor space

12 Portable 16 Pedestal 18 Web 20 4-4  
21 Patio & Cafe 22 Shaded

### Essential Frame Styles

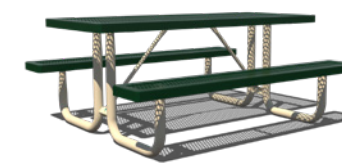

Portable



Pedestal



Web

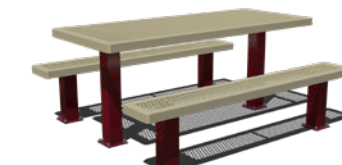

4-4



Utility



Cafe

### Essential Key Features



#### Signature Coating

Our textured polyethylene and thermoplastic coatings are durable and easily repaired.



#### Personalized Products

Add your logo, emblem, or design to market your brand and leave a visual impression.



#### Variety of Patterns

Available in a variety of metal pattern designs — all great for drainage and durability.



#### Child Sizes Available

Select products are available with a 14" seat height suitable for children.

### See Before You Buy

Classic Square Web Table



#### Product Videos

Learn details of our most popular tables and see them up close before you buy. Watch them on our YouTube channel: [youtube.com/c/SuperiorRecreationalProducts](https://youtube.com/c/SuperiorRecreationalProducts)



#### Color Selection

Use our color applier tool to select and preview your color choice before you buy. Visit [srpsiteamenities.com/design-tools/color-applier](https://srpsiteamenities.com/design-tools/color-applier).





### Rectangular Portable Table

#### SPECIFICATIONS

- 2 3/8" powder coated frame
- Pre-drilled surface mount holes
- Available with or without seat backs
- Where applicable, replace (#) with length desired

METAL DESIGN	PRODUCT NO.	LENGTHS (#)
<b>STANDARD</b>		
Regal 	T#RC	4', 6', 8', 10'
Perforated	T#PERF	6', 8'
Innovated	T#INNV	4', 6', 8', 10'
Rolled	T#ROLL	6', 8'
<b>STANDARD WITH SEAT BACKS</b>		
Regal	T#RCWB	6', 8'

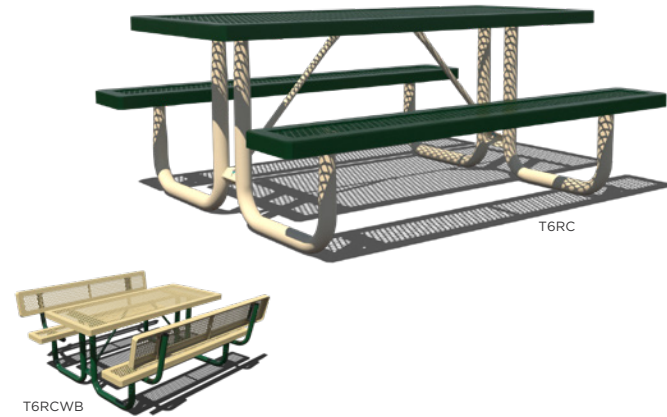

### Accessible Rectangular Portable Table

#### SPECIFICATIONS

- 2 3/8" powder coated frame
- 24" of overhang for ADA accessibility
- Pre-drilled surface mount holes
- Available with standard or centered seats
- Includes anti-vandalism brace
- Where applicable, replace (#) with length desired

METAL DESIGN	PRODUCT NO.	LENGTHS (#)
<b>STANDARD</b>		
Regal	T#RCHDCP	6', 8'
Perforated	T#PERFHDCP	6', 8'
Innovated	T#INNVHDCP	6', 8'
Rolled	T8ROLLHDCP	8'
<b>ACCESSIBLE WITH CENTERED SEATS</b>		
Regal	T8RCHDCPALT	8'
Perforated	T8PERFHDCPALT	8'
Innovated	T8INNVHDCPALT	8'

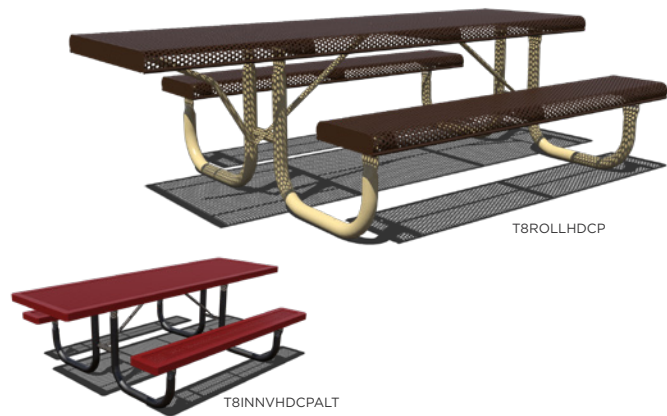

### Walk Through Accessible Rectangular Portable Table

#### SPECIFICATIONS

- 2 3/8" powder coated frame
- 2 points of ADA accessibility
- Pre-drilled surface mount holes
- Includes anti-vandalism brace

METAL DESIGN	PRODUCT NO.	LENGTH
Innovated	T10INNVHDCP	10'
Expanded Metal	T10HDCP	10'



### Square Portable Table

#### SPECIFICATIONS

- 1 5/8" powder coated frame
- 46" square table top featuring standard umbrella hole
- Pre-drilled surface mount holes
- Available with or without seat backs

METAL DESIGN	PRODUCT NO.	SEATS
<b>WITHOUT SEAT BACKS</b>		
Regal 	T46RC	3, 4
Perforated	T46PERF	3, 4
Classic	T46CLASS	3, 4
<b>WITH SEAT BACKS</b>		
Regal	T46RCWB	4



  
Product Video Available  
PAGE 4

  
Personalize Your Product  
PAGE 4

  
Metal Design Options  
PAGE 72

  
Child Sized Tables Available  
PAGE 42

  
View in 360° & Apply Colors  
PAGE 2





T46CLASS-3ADA

**Accessible Square Portable Table**

**SPECIFICATIONS**

- 1 5/8" powder coated frame
- Pre-drilled surface mount holes
- Extended 57" table top
- Features standard umbrella hole
- Features 3 seats

METAL DESIGN	PRODUCT NO.
Regal	T46RC-3ADA
Classic	T46CLASS-3ADA

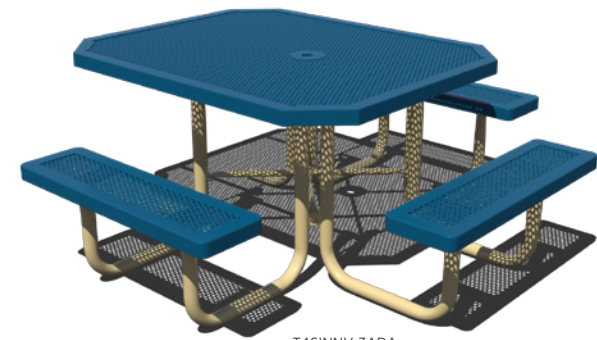

T46INNV-3ADA

**Accessible Octagon Portable Table**

**SPECIFICATIONS**

- 1 5/8" powder coated frame
- Pre-drilled surface mount holes
- Extended 57" table top
- Features standard umbrella hole
- Features 3 seats

METAL DESIGN	PRODUCT NO.
Regal	T46OCT-3ADA
Rolled	T46OCTROLL-3ADA
Innovated	T46INNV-3ADA

**Octagon Portable Table**

**SPECIFICATIONS**

- 1 5/8" powder coated frame
- 46" octagon table top featuring standard umbrella hole
- Pre-drilled surface mount holes
- Available with or without seat backs

METAL DESIGN	PRODUCT NO.	SEATS
<b>STANDARD</b>		
Regal	T46OCT	3, 4
Perforated	T46OCTPERF	3, 4
Rolled	T46OCTROLL	3, 4
Innovated	T46INNV	3, 4
<b>STANDARD WITH SEAT BACKS</b>		
Regal	T46OCTWB	4



T46RACS

**Round Portable Table**

**SPECIFICATIONS**

- 1 5/8" powder coated frame
- 46" round table top featuring standard umbrella hole
- Pre-drilled surface mount holes
- Available with standard or solid top

METAL DESIGN	PRODUCT NO.	SEATS
<b>STANDARD TOP</b>		
Regal 	T46RACS	3, 4
Innovated	T46RACSINNV	3, 4
<b>SOLID TOP</b>		
Regal	TS46RACS	3, 4



T46OCTROLL



T46OCTWB



TS46RACS

Your Logo  
Personalize Your Product  
PAGE 4

Metal Design Options  
PAGE 72

Child Sized Tables Available  
PAGE 42

360°  
View in 360° & Apply Colors  
PAGE 2

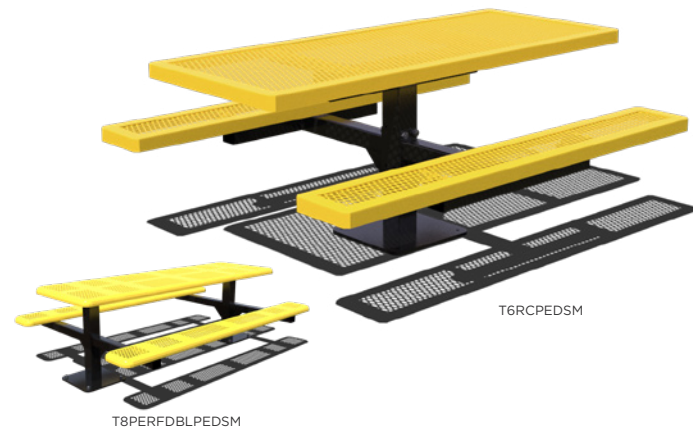

**Rectangular Pedestal Table**

**SPECIFICATIONS**

- Heavy-duty 4" square powder coated frame
- 8' version features double pedestal frame
- Add SM (surface mount) or S (in-ground mount) to end of product number
- Select metal design styles accessible by design

METAL DESIGN	6' LENGTH	8' LENGTH
Regal	T6RCPED	T8RCDBLPED
Perforated	T6PERFPED	T8PERFDBLPED
Innovated	T6INNVPED	T8INNVDLPED
Rolled	T6ROLLPED	

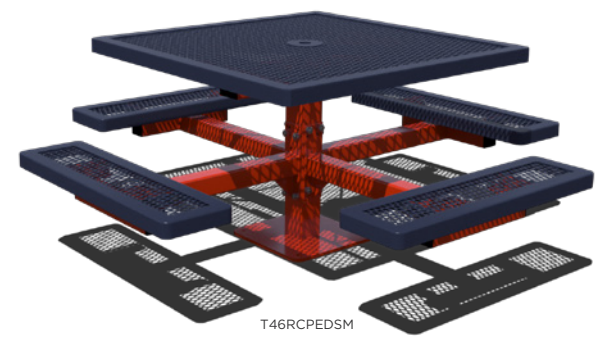

**Square Pedestal Table**

**SPECIFICATIONS**

- Heavy-duty 4" square powder coated frame
- Perforated option features 2 7/8" round support arms
- 46" square table top featuring standard umbrella hole
- Portable (POR), surface (SM), or in-ground mount (S)

METAL DESIGN	PRODUCT NO.	SEATS
Regal	T46RCPED	3, 4
Perforated	T46PERFPED	3, 4
Classic	T46CLASSPED	3, 4

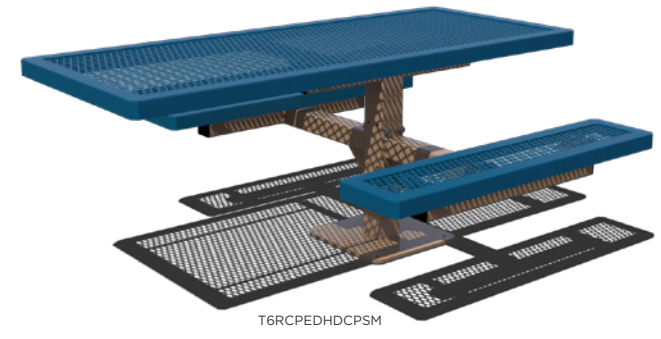

**Accessible Rectangular Pedestal Table**

**SPECIFICATIONS**

- Heavy-duty 4" square powder coated frame
- 8' version features double pedestal frame
- 24" of overhang for ADA accessibility
- Add SM (surface mount) or S (in-ground mount) to end of product number

METAL DESIGN	6' LENGTH	8' LENGTH
Regal	T6RCPEDHDCP	T8RCDBLPEDHDCP



**Round Pedestal Table**

**SPECIFICATIONS**

- Heavy-duty 4" square frame with 2 7/8" round support arms
- 46" round table top featuring standard umbrella hole
- Surface (SM) or in-ground mount (S)

METAL DESIGN	PRODUCT NO.	SEATS
Expanded Metal	T46RACSPED	3, 4

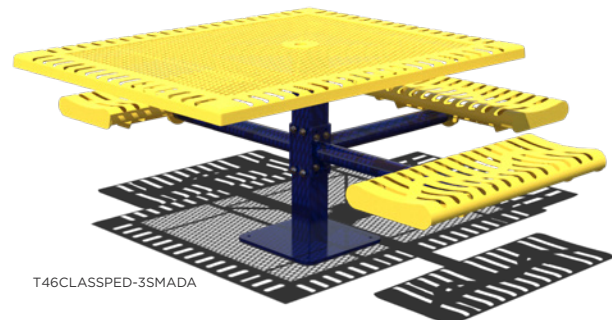

**Accessible Square Pedestal Table**

**SPECIFICATIONS**

- Heavy-duty 4" square powder coated frame
- Extended 57" table top featuring standard umbrella hole
- Portable (POR), surface (SM), or in-ground mount (S)

METAL DESIGN	PRODUCT NO.
Regal	T46RCPED-3#ADA
Classic	T46CLASSPED-3#ADA

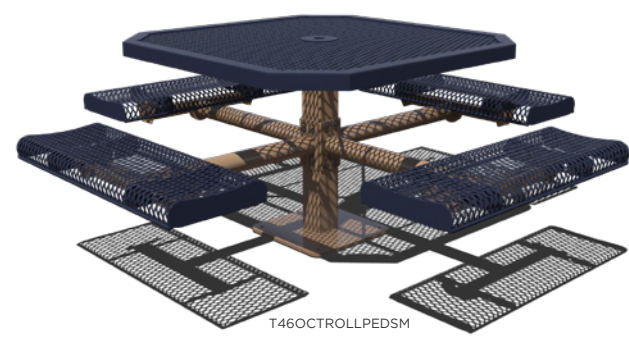

**Octagon Pedestal Table**

**SPECIFICATIONS**

- Heavy-duty 4" square frame with 2 7/8" round support arms
- 46" octagon table top featuring standard umbrella hole
- Surface (SM) or in-ground mount (S)

METAL DESIGN	PRODUCT NO.	SEATS
Innovated	T46INNVPED	2, 3, 4
Rolled	T46OCTROLLPED	2, 3, 4



T46OCTROLLPED-3SMADA

### Accessible Octagon Pedestal Table

#### SPECIFICATIONS

- Heavy-duty 4" square frame with 2 7/8" round support arms
- 46" octagon table top featuring standard umbrella hole
- Replace (#) in product number with SM (surface mount) or S (in-ground mount)
- Features 3 seats

METAL DESIGN	PRODUCT NO.
Innovated	T46INNVPED-3#ADA
Rolled	T46OCTROLLPED-3#ADA



T46WEBOCTPSM

### Octagon Web Table

#### SPECIFICATIONS

- 2 3/8" powder coated frame
- 46" octagon table top featuring standard umbrella hole
- Portable/surface (PSM) or in-ground mount (S)

METAL DESIGN	PRODUCT NO.	SEATS
Regal	T46WEBOCT	3, 4

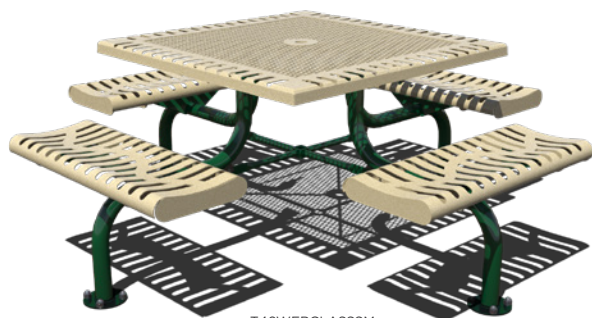

T46WEBCLASSSM

### Square Web Table

#### SPECIFICATIONS

- 2 3/8" powder coated frame
- 46" square table top featuring standard umbrella hole
- Surface (SM) or in-ground mount (S)

METAL DESIGN	PRODUCT NO.	SEATS
Regal	T46WEB	3, 4
Classic	T46WEBCLASS	3, 4



T46WEBOCT-3SMADA

### Accessible Octagon Web Table

#### SPECIFICATIONS

- 2 3/8" powder coated frame
- Extended 57" octagon table top featuring standard umbrella hole
- 3 seats
- Replace (#) in product number with SM (surface mount) or S (in-ground mount)

PRODUCT NO.: T46WEBOCT-3#ADA

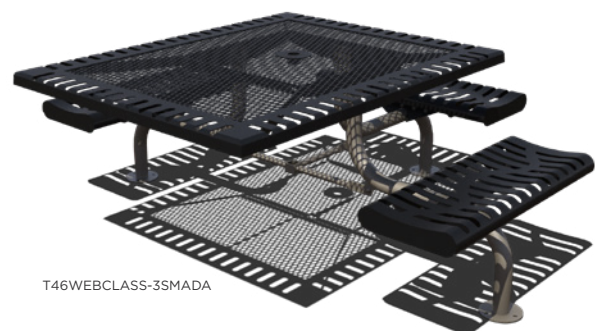

T46WEBCLASS-3SMADA

### Accessible Square Web Table

#### SPECIFICATIONS

- 2 3/8" powder coated frame
- Extended 57" square table top featuring standard umbrella hole
- Features 3 seats
- Replace (#) in product number with SM (surface mount) or S (in-ground mount)

METAL DESIGN	PRODUCT NO.
Regal	T46WEB-3#ADA
Classic	T46WEBCLASS-3#ADA

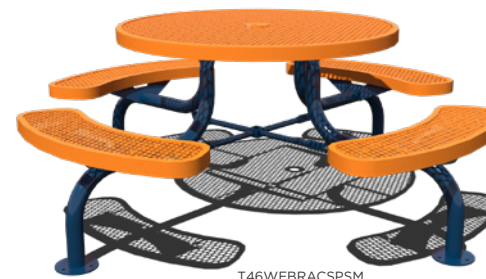

T46WEBRACSPSM

### Round Web Table

#### SPECIFICATIONS

- 2 3/8" powder coated frame
- 46" round table top featuring standard umbrella hole
- Portable/surface (PSM) or in-ground mount (S)

METAL DESIGN	PRODUCT NO.	SEATS
Regal	T46WEBRACS	3, 4

Product Video Available  
PAGE 4

Your Logo  
Personalize Your Product  
PAGE 4

Metal Design Options  
PAGE 72

Mounting Accessories  
PAGE 23

View in 360° & Apply Colors  
PAGE 2



T6RC4-4SM

### 4-4 Table

#### SPECIFICATIONS

- Heavy-duty 4" square powder coated frame
- Detached seating
- Add SM (surface mount) or S (in-ground mount) to end of product number

METAL DESIGN	PRODUCT NO.	LENGTHS (#)
Regal	T#RC4-4	6', 8'
Perforated	T#PERF4-4	6', 8'
Innovated	T#INNV4-4	6', 8'
Rolled	T6ROLL4-4	6'



T6RCHDCP4-4SM

### ♿ Accessible 4-4 Table

#### SPECIFICATIONS

- Heavy-duty 4" square powder coated frame
- Detached seating
- 24" of overhang for ADA accessibility
- Add SM (surface mount) or S (in-ground mount) to end of product number

METAL DESIGN	PRODUCT NO.	LENGTHS (#)
Regal	T#RCHDCP4-4	6', 8'
Perforated	T8PERFHDCP4-4	8'
Innovated	T8INNVHDCP4-4	8'
Rolled	T6ROLLHDCP4-4	6'



T6UP

### Rectangular Portable Utility Table

#### SPECIFICATIONS

- 2 3/8" powder coated frame
- Pre-drilled surface mount holes available for additional charge

METAL DESIGN	PRODUCT NO.	LENGTHS (#)
Regal	T#UP	4', 6', 8', 10'



T36ROUND

### Round Portable Cafe Table

#### SPECIFICATIONS

- 1 5/8" powder coated frame
- Features standard umbrella hole
- Features expanded metal table top design
- 36" or 46" top diameter options

PRODUCT NO.	TOP DIAMETER
T##ROUND	36", 46"



T36CAFESM

### Bar Height Pedestal Cafe Table

#### SPECIFICATIONS

- 2 3/8" powder coated frame
  - 42" table height and 36" top diameter
  - Features expanded metal table top design
  - Add SM (surface mount) or S (in-ground mount) to end of product number
- PRODUCT NO.: T36CAFE





T42PEDBAR

### Bar Height Pedestal Table with Attached Seats

#### SPECIFICATIONS

- 2 3/8" powder coated frame
- Features standard umbrella hole
- 42" table height and 46" top diameter
- Features expanded metal table top and seat design
- Pre-drilled holes for optional surface mounting

PRODUCT NO.: T42PEDBAR



T42RASS

### Round Portable Cafe Table with Attached Seats

#### SPECIFICATIONS

- 2 3/8" powder coated frame
- 46" top diameter
- Available with 3 or 4 seats
- For 3 seats, add -3 to end of product number
- Pre-drilled holes for optional surface mounting

METAL DESIGN	PRODUCT NO.	SEATS
Expanded Metal 	T42RASS	3, 4
Innovated	T42RASSINNV	3, 4

### Shaded Table

#### SPECIFICATIONS

- 6' Regal table with 8' seats and 12.5' x 8' shade
- Includes Glide Elbow, a fabric release mechanism
- Only available as in-ground mount

PRODUCT NO.: TRU120808IG

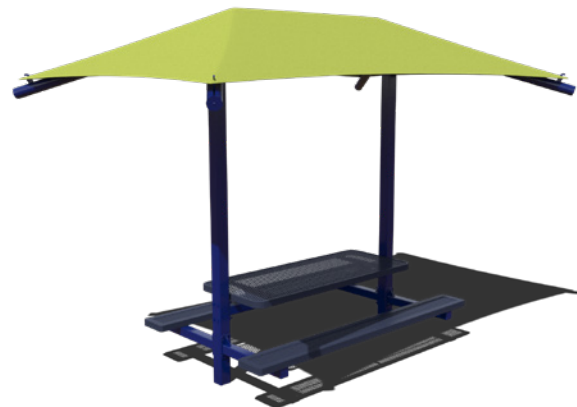

## Table Accessories



### Market Umbrella

- 7.5' DIAMETER | 7.5UMB-MRKT-FG
- 9' DIAMETER | 9.0UMB-MRKT-FG
- Available in two diameters
- Features heavy gauge pulley system
- Features fiberglass frame
- Marine-grade acrylic fabric
- Multiple color options available



### Patio Umbrella

- STEEL FRAME | 7.5UMB-PATIO-ST
- FIBERGLASS FRAME | 7.5UMB-PATIO-FG
- Available in 7.5' diameter
- Choice of steel or fiberglass frame
- Features crank lift with tilt frame
- Multiple color options available



### Mounting Cover Set

- SMALL\_SURF\_CVR\_SET
- 2 3/8" diameter
- Hides mounting plates
- Sold as a set of two
- Two-piece design for ease of installation
- Powder coat finish



### In-Ground Post Set

- INGRDPOST-PC
- Allows for portable tables to be in-ground mounted
- Sold as a set of two
- Powder coat finish



### Surface Mount Clamp Set

- CLAMP-SET
- Allows for portable tables to be surface mounted
- Sold as a set of two
- Galvanized finish

### Umbrella Stand

- WHITE | UMB-BASE-WH
- BLACK | UMB-BASE-BK
- 16" diameter
- Filled with concrete



### Umbrella Anchor

#### UBRACE

- All-aluminum
- Attaches under table to secure umbrella and prevent umbrella from flying away



### Sleep Inhibitor for Seats

#### SLEEPSEAT

- Inhibits sleeping on table or bench seats
- Attaches to middle of seat



### Table Shade

- 6' TABLE | STS765IG OR STS765SM
- 8' TABLE | STS785IG OR STS785SM
- Available widths for 6' or 8' table designs
- In-ground (IG) or surface (SM) mounting
- Features commercial-grade fabric and powder coat frame





## Essentials Bench COLLECTION

a traditional line of coated outdoor benches suitable for a variety of outdoor spaces

- 26 Standard 27 4-4 28 Metro 29 Classic & Casino 30 Modern  
31 Wingline & Geometric 32 Patio Chairs, Swing, & Shaded

### Our Essential Frame Styles



Standard



4-4



Metro



Classic



Casino



Modern



Wingline

### Essential Key Features



#### Signature Coating

Our textured polyethylene and thermoplastic coatings are durable and easily repaired.



#### Personalized Products

Add your logo, emblem, or design to market your brand and leave a visual impression.



#### Variety of Patterns

Available in a variety of metal pattern designs — all great for drainage and durability.



#### Child Sizes Available

Select products are available with a 14" seat height suitable for children.

### See Before You Buy

Regal Standard Bench with Back



#### Product Videos

Learn details of our most popular benches and see them up close before you buy. Watch them on our YouTube channel: [youtube.com/c/SuperiorRecreationalProducts](https://youtube.com/c/SuperiorRecreationalProducts)





### Standard Bench with Back

#### SPECIFICATIONS

- 2 3/8" powder coated frame
- Add P (portable), SM (surface mount), or S (in-ground mount) to end of product number
- 10' and 15' lengths consist of two smaller sections bolted together
- 10" seat width and 17" seat height

METAL DESIGN	PRODUCT NO.	LENGTHS (#)
Regal	B#WBRC	4', 6', 8', 10', 15'
Perforated	B#WBPERF	6', 8'
Innovated	B#WBINNV	4', 6', 8', 10', 15'
Rolled	B#WBROLL	6', 8'



### Standard Bench without Back

#### SPECIFICATIONS

- 2 3/8" powder coated frame
- Add P (portable), SM (surface mount), or S (in-ground mount) to end of product number
- 10' and 15' lengths consist of two smaller sections bolted together
- 10" seat width and 17" seat height

METAL DESIGN	PRODUCT NO.	LENGTHS (#)
Regal	B#RC	4', 6', 8', 10', 15'
Perforated	B#PERF	6', 8'
Innovated	B#INNV	6', 8', 10', 15'
Rolled	B#ROLL	6', 8'

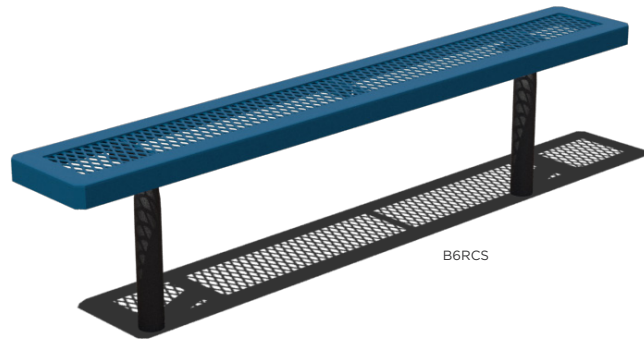

### Standard Bench without Back with Deluxe Seats

#### SPECIFICATIONS

- 2 3/8" powder coated frame
- Add P (portable), SM (surface mount), or S (in-ground mount) to end of product number
- 10' and 15' lengths consist of two smaller sections bolted together
- 15" seat width and 17" seat height

METAL DESIGN	PRODUCT NO.	LENGTHS
Regal	B#PLAYERRC	4', 6', 8', 10', 15'
Innovated	B#PLAYERINNV	4', 6', 8', 10', 15'

### 4-4 Bench

#### SPECIFICATIONS

- Heavy-duty 4" square powder coated frame
- Add SM (surface mount) or S (in-ground mount) to end of product number
- 10" seat width and 17" seat height

METAL DESIGN	PRODUCT NO.	LENGTHS (#)
Regal	B#WBRC4-4	6', 8'
Perforated	B#WBPERF4-4	6', 8'
Innovated	B#WBINNV4-4	6', 8'



Product Video Available  
PAGE 4

Personalize Your Product  
PAGE 4

Metal Design Options  
PAGE 72

Child Sized Tables Available  
PAGE 42

360° View in 360° & Apply Colors  
PAGE 2



**Double 4-4 Bench**

**SPECIFICATIONS**

- Double-sided bench
- Heavy-duty 4" square powder coated frame
- Add SM (surface mount) or S (in-ground mount) to end of product number
- 10" seat width and 17" seat height

METAL DESIGN	PRODUCT NO.	LENGTHS (#)
Regal	B#WBRC4-4	6', 8'
Perforated	B#WBPERFD4-4	6', 8'
Innovated	B#WBINNVD4-4	6', 8'



**Portable Classic Bench & Add-On**

**SPECIFICATIONS**

- Cast aluminum, powder coated frame
- Portable with pre-drilled holes for optional surface mounting
- Contoured back
- Add-on bench sections available
- 16 1/2" seat height
- Classic wave design

VERSION	PRODUCT NO.	LENGTHS (#)
Standard	B#WBCLASSIC	4', 5', 6'
Add-On	B#WBCLASSIC-ADDON	4', 5', 6'



**Metro Bench**

**SPECIFICATIONS**

- 7 gauge steel seat with 3/4" steel plate legs
- Solid, one-piece design
- Requires no assembly or hardware
- Portable with pre-drilled holes for optional surface mounting
- Fully textured polyethylene or thermoplastic coated

PRODUCT NO.	LENGTHS (#)
B#WBMETRO	4', 6'

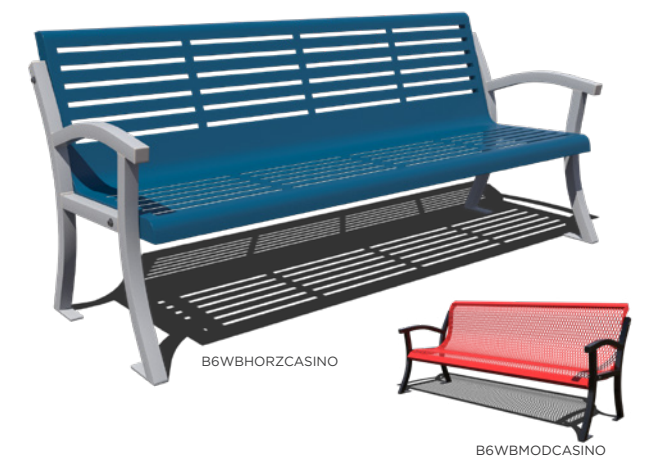

**Portable Casino Bench with Back**

**SPECIFICATIONS**

- 1 1/2" square textured polyethylene or thermoplastic legs and arms
- Portable with pre-drilled holes for optional surface mounting
- Contoured back
- Optional custom center armrest
- 16 1/2" seat height

METAL DESIGN	PRODUCT NO.	LENGTHS (#)
Modern	B#WBMODCASINO	4', 6'
Horizontal Strap	B6WBHORZCASINO	6'

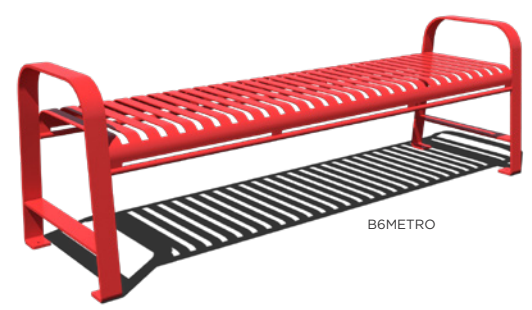

**Metro Bench without Back**

**SPECIFICATIONS**

- 7 gauge steel seat with 3/4" steel plate legs
- Solid, one-piece design
- Requires no assembly or hardware
- Portable with pre-drilled holes for optional surface mounting
- Fully textured polyethylene or thermoplastic coated

PRODUCT NO.	LENGTHS (#)
B#METRO	4', 6'

**Product Video Available**  
PAGE 4

**Your Logo**  
Personalize Your Product  
PAGE 4

**Metal Design Options**  
PAGE 72

**View in 360° & Apply Colors**  
PAGE 2





**Modern Bench with Back & Add-On**

- SPECIFICATIONS**
- Heavy-duty 2 3/8" powder coated frame
  - Add PSM (portable/surface mount) or S (in-ground mount) to end of product number or before (-) for add-on
  - Contoured back with armrests
  - Add-on bench sections available
  - Seat height is 18"

METAL DESIGN	VERSION	PRODUCT NO.	LENGTHS (#)
Standard	Standard	B#WBMODERN <a href="#">360°</a>	4', 6'
	Add-On	B#WBMODERN-ADDON	4', 6'
Classic	Standard	B#WBMODCLASS	4', 6'
	Add-On	B#WBMODCLASSIC-AD	4', 6'

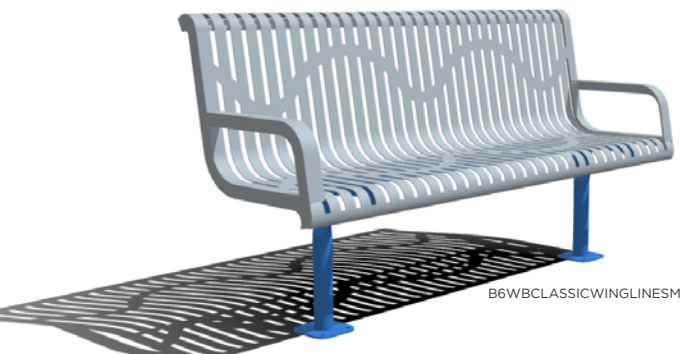

**Wingline Bench**

- SPECIFICATIONS**
- Heavy-duty 2 3/8" powder coated frame
  - Add P (portable), SM (surface mount), or S (in-ground mount) to end of product number
  - Contoured back with armrests
  - Seat height is 18"

METAL DESIGN	PRODUCT NO.	LENGTHS (#)
Classic <a href="#">360°</a>	B#WBCLASSICWINGLINE	4', 6'
Standard	B#WBWINGLINE	4', 6'



**Modern Bench without Back & Add-On**

- SPECIFICATIONS**
- Heavy-duty 2 3/8" powder coated frame
  - Add PSM (portable/surface mount) or S (in-ground mount) to end of product number or before (-) for add-on
  - Add-on bench sections available
  - Seat height is 18"

METAL DESIGN	VERSION	PRODUCT NO.	LENGTHS (#)
Standard	Standard	B#MODERN	4', 6'
	Add-On	B#MODERN-ADDON	4', 6'
Classic	Standard	B#MODCLASS	4', 6'
	Add-On	B#MODCLASSIC-ADDON	4', 6'

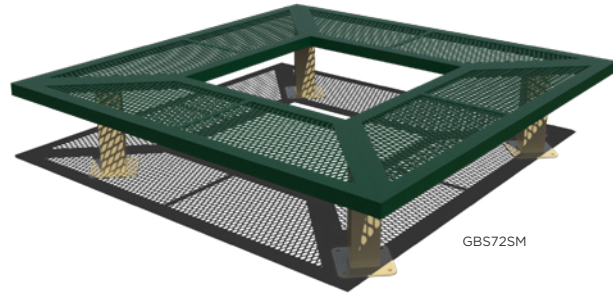

**Geometric Bench**

- SPECIFICATIONS**
- Heavy-duty 4" powder coated frame
  - 3/4" #9 expanded metal
  - Add SM (surface mount), or S (in-ground mount) to end of product number
  - 20" seat width with 4" tall outside border

PRODUCT NO.	LENGTH (##)
GBS##	72", 96"

[Mounting Accessories](#)  
PAGE 33

[Your Logo](#)  
Personalize Your Product  
PAGE 4

[Metal Design Options](#)  
PAGE 72

[360°](#)  
View in 360° & Apply Colors  
PAGE 2



### Stacking Patio Chair

#### SPECIFICATIONS

- 3/4" #9 expanded metal
  - 18" seat height
  - Stackable and portable
  - Contoured two-piece seat/seat back design
  - Pairs with Portable Utility and Cafe Tables
- PRODUCT NO.: CSTACK



### Barstool

#### SPECIFICATIONS

- 3/4" #9 expanded metal contour seat
  - 30" seat height and 18" seat width
  - Portable
  - Pairs with Bar Height Pedestal Cafe Table (T36CAFE)
- PRODUCT NO.: BARSTOOL



B4WBMODSWING

### Bench Swing

#### SPECIFICATIONS

- Heavy-duty 2 3/8" powder coated frame
- 3/4" #9 expanded metal
- Includes uncoated galvanized swing chain
- In-ground mount
- Contoured back with armrests

PRODUCT NO.	LENGTHS (#)
B#WBMODSWING	4', 6'

### Shaded Bench

#### SPECIFICATIONS

- 8' Regal bench with 12.5' x 8' shade
  - Includes Glide Elbow™ fabric release mechanism
  - Only available as in-ground mount
- PRODUCT NO.: BRU120808IG

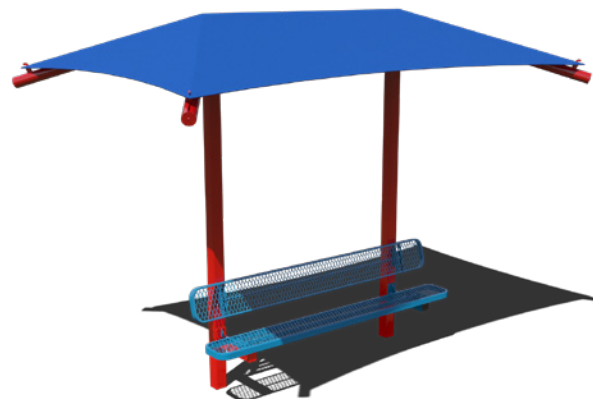

## Bench Accessories



### Mounting Cover Set

SMALL\_SURF\_CVR\_SET

- 2 3/8" diameter
- Hides mounting plates
- Sold as a set of two
- Two-piece design for ease of installation
- Powder coat finish



### Sleep Inhibitor for Seats

SLEEPSEAT

- Inhibits sleeping on table or bench seats
- Attaches to middle of seat



### Integrated Bench Shade

STS765BA

- Attaches to Standard Benches with Backs
- Available only for benches that are in-ground or surface mount
- Features commercial-grade fabric and black powder coat frame



### Freestanding Bench Shade

6' BENCH | STS765IG OR STS765SM

8' BENCH | STS785IG OR STS785SM

- Available widths for 6' or 8' bench designs
- In-ground (IG) or surface (SM) mounting
- Features commercial-grade fabric and powder coat frame



## Essentials Site Accessories

COLLECTION

a traditionally designed line of essential site accessories

**35** Bike Racks   **36** Bike Rack Shelters   **38** Trash Receptacles  
**40** Planter and Grills   **41** Bollards & Solar Amenities

Qualifying Products Available for Quick Ship



**Cyclist Bike Rack**  
Accommodates 2 bikes  
PRODUCT NO.: CYCLIST



**Slope Bike Rack**  
Accommodates 2 bikes  
PRODUCT NO.: SLOPE



**Horse Shoe Bike Rack**  
Accommodates 2 bikes  
PRODUCT NO.: HORSESHOE



**Ring Bike Bollard**  
Accommodates 2 bikes  
PRODUCT NO.: RINGBOLLARD



**Bike Loop Rack**  
Accommodates 2 bikes  
PRODUCT NO.: T-BILOOP



**Post Bike Bollard**  
Accommodates 2 bikes  
PRODUCT NO.: BIKEPOST

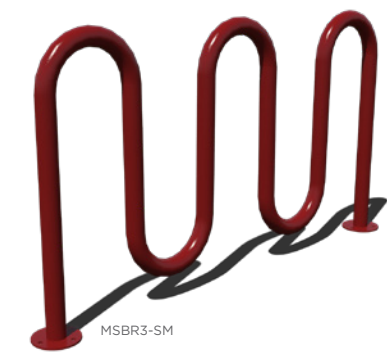

**Wave Bike Rack**

Options for 5, 7, 11, or 13 bikes

BIKE COUNT	WAVE COUNT	PRODUCT NO.
5	2	MSBR2
7	3	MSBR3
11	5	MSBR5
13	6	MSBR6

**Mounting**  
Surface Mount (-SM)  
In-Ground Mount (-ING)

**Finish**  
Powder Coated Finish



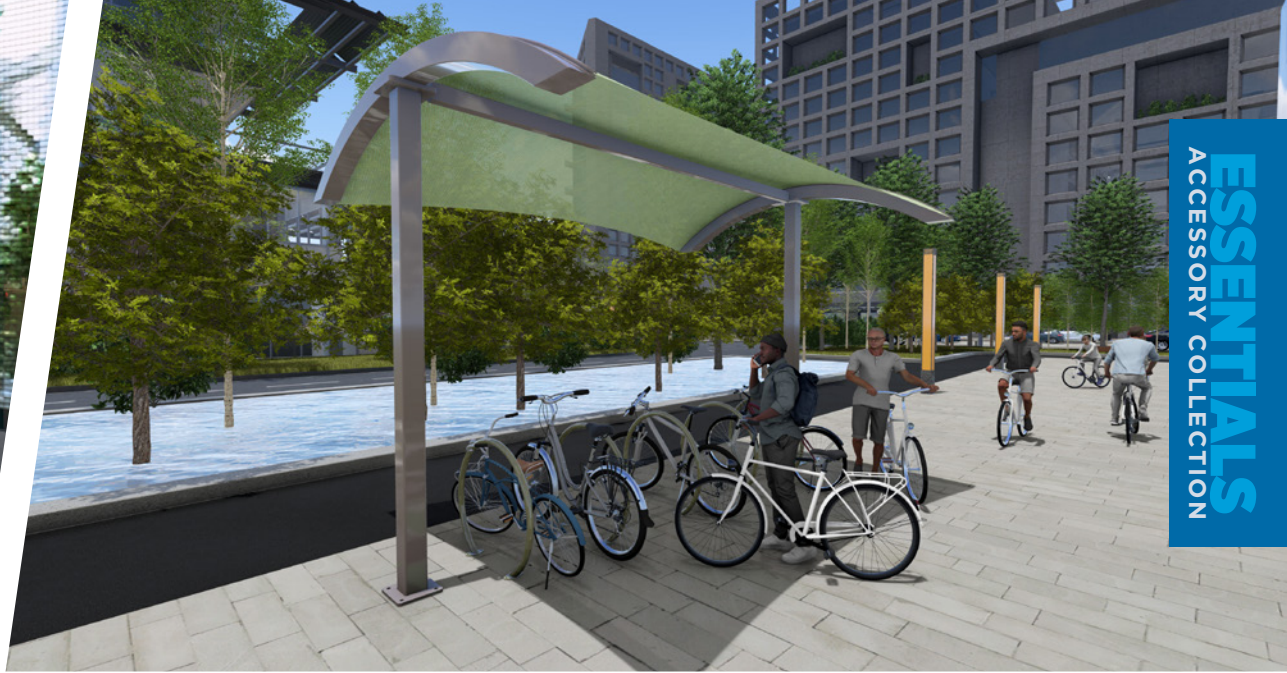

**NEW!** 10.5' x 10' All-Steel Bike Shelter

**SPECIFICATIONS**

- Cantilevered design maximizes usable space by eliminating obstructive supports, allowing for easy access to bike racks
- Extended roof shields bikes and riders from rain, sun, and snow
- Available with 3 Horse Shoe Bike Racks that provide a designated and secure area for locking bikes
- Available without bike racks for installation over existing bike racks

VERSION	PRODUCT NO.
With Bike Racks	BRS-0001
Without Bike Racks	BSO-0008XX



**NEW!** 10.5' x 30' All-Steel Bike Shelter

**SPECIFICATIONS**

- Cantilevered design maximizes usable space by eliminating obstructive supports, allowing for easy access to bike racks
- Extended roof shields bikes and riders from rain, sun, and snow
- Available with 8 Horse Shoe Bike Racks that provide a designated and secure area for locking bikes
- Available without bike racks for installation over existing bike racks

VERSION	PRODUCT NO.
With Bike Racks	BRS-0003
Without Bike Racks	BSO-0010XX

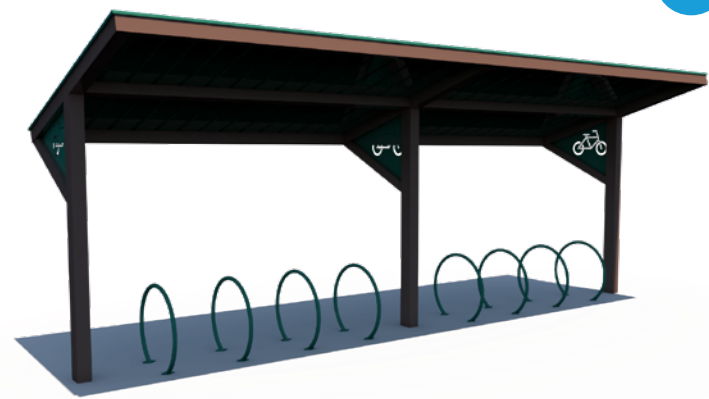

**NEW!** 10.5' x 15' All-Steel Bike Shelter

**SPECIFICATIONS**

- Cantilevered design maximizes usable space by eliminating obstructive supports, allowing for easy access to bike racks
- Extended roof shields bikes and riders from rain, sun, and snow
- Available with 4 Horse Shoe Bike Racks that provide a designated and secure area for locking bikes
- Available without bike racks for installation over existing bike racks

VERSION	PRODUCT NO.
With Bike Racks	BRS-0002
Without Bike Racks	BSO-0009XX

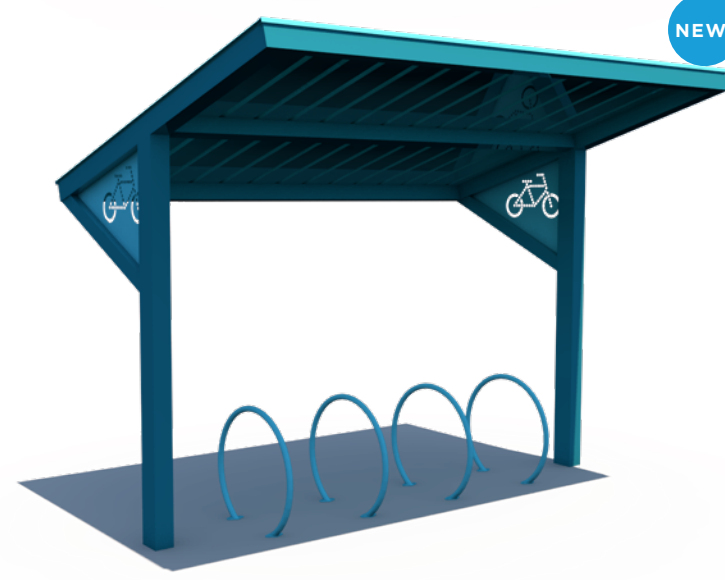

**NEW!** Fabric Top Bike Shelter

**SPECIFICATIONS**

- Cantilevered design maximizes usable space by eliminating obstructive supports, allowing for easy access to bike racks
- Available with Horse Shoe Bike Racks that provide a designated and secure area for locking bikes
- Available without bike racks for installation over existing bike racks

VERSION	SIZE	PRODUCT NO.	RACK QUANTITY
With Bike Racks	10' x 10' x 8'	BAC101008SN	3
	15' x 10' x 8'	BAC151008SN	5
	30' x 10' x 8'	BAC301008SN	10
Without Bike Racks	10' x 10' x 8'	AC101008SN	N/A
	15' x 10' x 8'	AC151008SN	N/A
	30' x 10' x 8'	AC301008SN	N/A

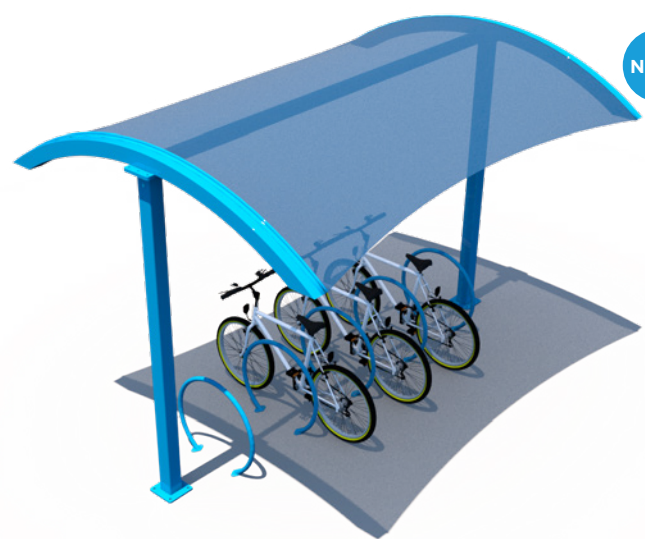



### Standard Trash Receptacle

#### SPECIFICATIONS

- 32 and 55 gallon options available
- Lid and liner sold separately

METAL DESIGN	PRODUCT NO.	CAPACITY
Regal 	TR##	32, 55
Perforated	TR32PERF	32
Classic	TR32CLASSIC	32



### Vertical Strap Trash Receptacle

#### SPECIFICATIONS

- 32 gallon
- Vertical ribbed steel design
- Lid included
- Liner sold separately
- Powder coated finish

PRODUCT NO.: TR32SLAT



### Tapered Trash Receptacle

#### SPECIFICATIONS

- 32 gallon
- Expanded metal design
- Lid and liner sold separately

PRODUCT NO.: TR32TAPER



### Crown Trash Receptacle

#### SPECIFICATIONS

- 36 gallon
- Vertical ribbed steel design with flared top
- Flat top lid and liner included

PRODUCT NO.: TR32CROWN



### Horizontal Strap Trash Receptacle

#### SPECIFICATIONS

- 32 gallon
- Horizontal ribbed steel design
- Lid and liner sold separately

PRODUCT NO.: TR32HORZ



### Metro Trash Receptacle

#### SPECIFICATIONS

- 36 gallon
- Vertical ribbed steel design with flared top
- Hinged side door for easy liner removal
- Flat top lid and liner included

PRODUCT NO.: TR32METRO

Easy Access Hinged Door

## Trash Receptacle Accessories



### Plastic Dome Top

DOME32-#

- Fits 32 gallon receptacles
- Available in black
- Made from heavy-duty plastic
- Cable attachment sold separately
- Features self-closing door to trap odor and deflect rain, debris, and pests



### Steel Dome Top

DOME32S

- Fits 32 gallon receptacles
- Textured polyethylene or thermoplastic finish
- Cable attachment sold separately
- Features galvanized, self-closing door to trap odor and deflect rain, debris, and pests

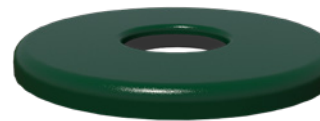

### Flat Top

- Fits 32 and 55 gallon receptacles
- 8" and 14" top opening available
- Textured polyethylene or thermoplastic finish

GALLON	OPENING	PRODUCT NO.
32	8"	FLATTOP32
32	14"	FLATTOP32-14
55	8"	FLATTOP55



### Flat Top with Rain Bonnet

FLATTOP32RB-HW

- Fits 32 gallon receptacles
- Textured polyethylene or thermoplastic finish
- 8" standard diameter opening (shown); 14" also available
- Features bonnet to deflect rain and debris



### Flat Top with Ash Bonnet

FLATTOP32AB-HW

- Fits 32 gallon receptacles
- Textured polyethylene or thermoplastic finish
- 8" standard diameter opening (shown); 14" also available
- Features sand tray for ashes

### Plastic Liner

32 GALLON | LINER32

55 GALLON | LINER55

- 55 gallon option available in gray
- 32 gallon option available in black
- Made from heavy-duty plastic



### Cable Attachment

CABLE

- Order with trash receptacle top to keep top secured to trash receptacle
- 18" long
- Made from 3/32" diameter braided cable



### Surface Mounting Kit

TR-SM-HW

- Includes hardware
- Powder coated



### In-Ground Mounting Kit

TR-ING-HW

- Includes hardware
- Powder coated



 Product Video Available  
PAGE 4

 Mounting Options Sold Separately  
PAGE 39

Your Logo  
Personalize Your Product  
PAGE 4

 Metal Design Options  
PAGE 72

360°  
View in 360° & Apply Colors  
PAGE 2



**Planter**

- SPECIFICATIONS**
- 24" wide x 18" high
  - Expanded metal design
  - Liner (Product No. 01-05-0212) sold separately
  - Portable and/or surface mount
  - Textured polyethylene or thermoplastic coated
- PRODUCT NO.: PLANTER-24IN



**Rotating Grill**

- SPECIFICATIONS**
- 20" wide x 15" deep x 10" high firebox
  - 300 square inches of cooking space
  - Rotates 360°
  - 4-level adjustable cooking grate has cooling coil handles
  - Durable rust resistant, high temp, black powder coated firebox
  - Galvanized, in-ground mount post
- PRODUCT NO.: GPS20



**Campfire Grill**

- SPECIFICATIONS**
- 28" wide x 39" deep x 8" high firebox
  - 532 square inches of cooking space per grill (1064 sq. in. total)
  - Cooling coil handles
  - Durable rust resistant, high temp, black powder coated firebox
  - In-ground or surface mounting (-SM) available
- PRODUCT NO.: GPS27D



**Bollard**

- SPECIFICATIONS**
- 8" diameter and 48" height
  - Powder coated finish
  - Add SM (surface mount) or S (in-ground mount) to end of product number

DESIGN	PRODUCT NO.
Standard	BOLLARD8
Zion	BOLLARD8Z



**Solar Charging Pole**

- SPECIFICATIONS**
- 30" round table
  - Reflective lettering
  - 4 dual 3.0 rapid-charge USB ports
  - Dedicated mobility device access port
  - 1-year limited warranty
  - Care kit (extra fuse, touch-up paint, and security screw bit)
- PRODUCT NO.: SOLARCHARGPOLE



**Solar Bench**

- SPECIFICATIONS**
- 6' Horizontal Slat Casino Bench Base
  - 2 Dual 2.0 Rapid-Charge USB ports
  - 1-year limited warranty
  - Care kit (extra fuse, touch-up paint, and security screw bit)
- PRODUCT NO.: SOLARCHARGBENCH

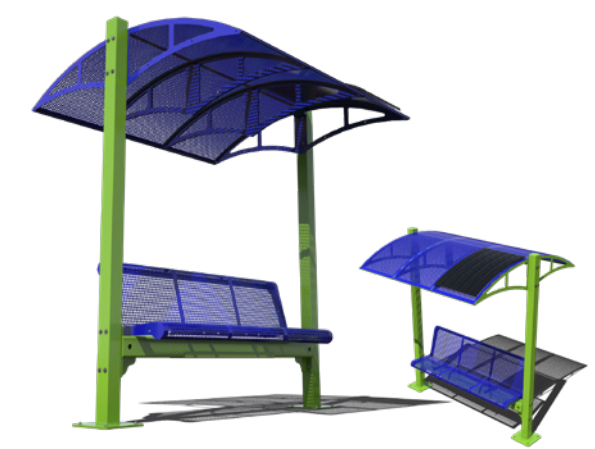

**Shaded Solar Bench**

- SPECIFICATIONS**
- Perforated with textured polyethylene or thermoplastic canopy and bench
  - Powder coated frame
  - Surface mount
  - 60-Watt polycrystalline solar panel
  - 2 dual 3.0 rapid-charge USB ports
  - Wet and over-temperature protection
- PRODUCT NO.: SOLARBENCHSHADE





**Early Childhood**  
COLLECTION

**Child-Sized Benches & Tables**



- Portable Children's Bench**
- 14" seat height
  - Available for Standard Benches With or Without Backs
  - Add "-ELEM" to end of qualifying product number



- Portable Children's Table**
- 14" seat height
  - Available for Standard Rectangular, Square, Octagon, or Round Portable Tables
  - Add "-ELEM" to end of qualifying product number

**Buddy Benches**

Our Buddy Benches are an industry favorite — and for a good reason. Buddy Benches are an ideal solution to combat loneliness and help foster friendships anywhere you can put them.

**Bench Options**

Bench options include most benches from our Essentials Bench Collection.



**Design Options**

Choose from our standard designs below and opt for a colored backing plate for a small upcharge.

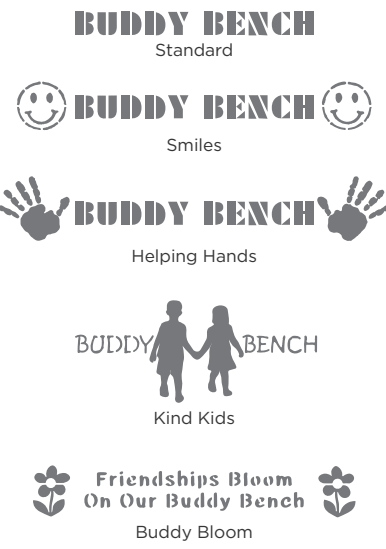

**Outdoor Classrooms**

**Outdoor Classroom with Benches**

- 30' x 20' Hip Shade
- 6' Basic UltraLeisure® Standard Bench without Back, Quantity of 9
- 32 Gallon Regal Standard Trash Receptacle

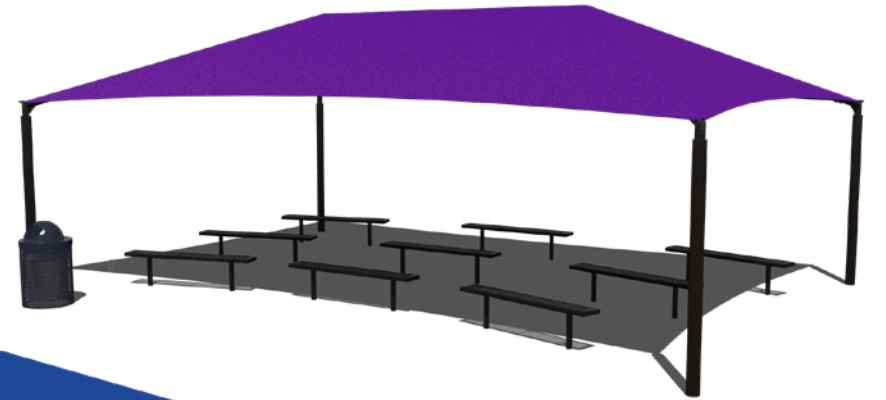

**Outdoor Classroom with Tables**

- 30' x 20' Hip Shade
- 6' Basic UltraLeisure® Rectangular Portable Table, Quantity of 6
- 32 Gallon Regal Standard Trash Receptacle





## Recycled COLLECTION

a collection of benches, tables, and trash receptacles  
made from eco-friendly materials

45 Benches 46 Tables 47 Trash Receptacles



PB6BFCONING

### Contour Bench

#### SPECIFICATIONS

- 6' or 8' length
- Cedar or gray 2" x 4" Resinwood slats
- Heavy duty, powder coated steel frames
- Stainless steel hardware
- In-ground or surface mount frame
- Add (ING) at end of product number for in-ground mount

PRODUCT NO.	LENGTHS (#)
PB#BFCON	6', 8'



PB6CPAE

### Comfort Park Avenue Bench

#### SPECIFICATIONS

- 6' or 8' length
- Cedar or gray 2" x 4" Resinwood slats
- Black recycled plastic base
- Stainless steel hardware
- Surface mount frame

PRODUCT NO.	LENGTHS (#)
PB#CPAE	6', 8'



PB6NEW

### Newport Bench

#### SPECIFICATIONS

- 6' or 8' length
- Cedar or gray 2" x 4" slats and 2" x 6" bullnosed slats
- Stainless steel hardware
- In-ground or surface mount frame

PRODUCT NO.	LENGTHS (#)
PB#NEW	6', 8'







### Park Place Standard & Accessible Portable Table

#### SPECIFICATIONS

- 6' or 8' length
- Cedar or gray 2" x 10" Resinwood slats
- Black recycled plastic contoured bases
- Stainless steel hardware
- Add ADA to end of product number (6' only)

PRODUCT NO.	LENGTHS (#)
PB#PARKP	6', 8'

### Hex Standard & Accessible Portable Table

#### SPECIFICATIONS

- 6' length
- Cedar or gray Resinwood slats
- Black recycled plastic base
- Stainless steel hardware
- Includes umbrella hole
- Add ADA to end of product number

PRODUCT NO.	LENGTH
PB6HEX	6'

### A-Frame Standard & Accessible Portable Table

#### SPECIFICATIONS

- 6' or 8' length
- Cedar or gray Resinwood slats
- Black recycled plastic base
- Stainless steel hardware
- Add ADA to end of product number (6' only)

PRODUCT NO.	LENGTHS (#)
PBAPIC#	6', 8'



### Round Recycled Trash Receptacle

#### SPECIFICATIONS

- 32 gallon
  - Cedar or gray 1" x 4" Resinwood slats
  - Maintenance-free molded plastic rings
  - Includes heavy-duty zinc-coated hardware
  - Removable plastic top provides access to liner
  - Liner sold separately
- PRODUCT NO.: PB32R

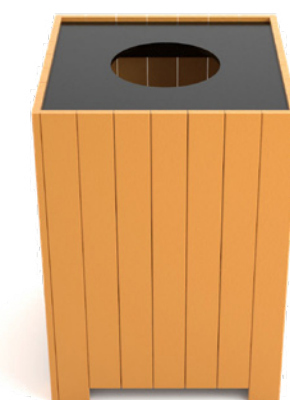

### Square Recycled Trash Receptacle

#### SPECIFICATIONS

- 32 gallon
  - Cedar or gray 1" x 4" Resinwood slats
  - Maintenance-free molded plastic rings
  - Includes heavy-duty zinc-coated hardware
  - Removable plastic top provides access to liner
  - Liner sold separately
- PRODUCT NO.: PB32S



**Uptown**  
COLLECTION

a premium collection of modern benches, tables,  
and trash receptacles

- 49 Zion & Rainier   50 Biscayne   51 Acadia   52 Bryce  
53 Cascades   54 Gateway   55 Samoa & Arches



**Zion Bench with Back**

**SPECIFICATIONS**

- 6' length
- Powder coated finish
- Legs are made from 3/4" laser cut steel plate
- Fully welded
- Combined portable/surface mount frame

ARMRESTS	PRODUCT NO.
No Armrests	B6WBZI
Side Armrests	B6WBZI-ARM
Side and Center Armrests	B6WBZI-ARM-CENTER

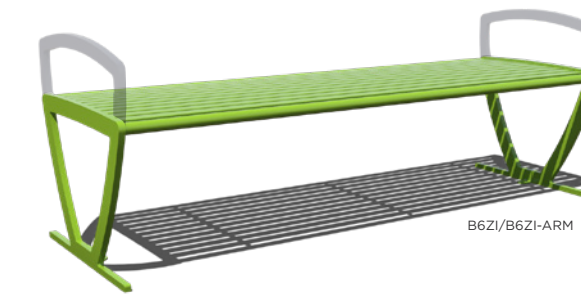

**Zion Bench without Back**

**SPECIFICATIONS**

- 6' length
- Powder coated finish
- Legs are made from 3/4" laser cut steel plate
- Fully welded
- Combined portable/surface mount frame

ARMRESTS	PRODUCT NO.
No Armrests	B6ZI
Side Armrests	B6ZI-ARM



**Zion Trash Receptacle**

**SPECIFICATIONS**

- 36 gallon capacity
- Powder coated finish
- Features 1 1/2" x 1/4" flat steel strips
- Lid and liner included

LID STYLE	PRODUCT NO.
Flat Top	TR36ZI-FLATTOP
Ash Bonnet	TR36ZI-FLATTOPAB
Rain Bonnet	TR36ZI-FLATTOPRB

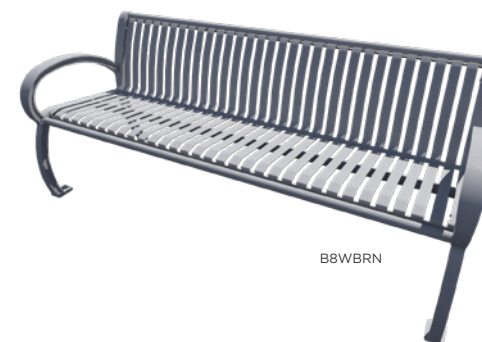

**Rainier Bench with Back**

**SPECIFICATIONS**

- 6' or 8' lengths available
  - Combined portable/surface mount frame with pre-drilled surface mount holes
  - Powder coated steel with cast aluminum frame
  - Fully welded
- PRODUCT NO.: B#WBRN





### Biscayne Bench with Back

#### SPECIFICATIONS

- 4', 6', or 8' lengths available
- Features 1 1/2" square tubing
- Combined portable/surface mount frame
- Powder coated finish
- Ships fully assembled
- Fully welded

PRODUCT NO.: B#WBBC

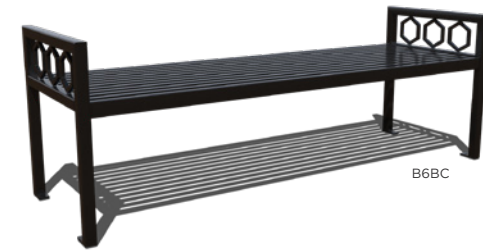

### Biscayne Bench without Back

#### SPECIFICATIONS

- 4', 6', or 8' lengths available
- Features 1 1/2" square tubing
- Combined portable/surface mount frame
- Powder coated finish
- Ships fully assembled
- Fully welded

PRODUCT NO.: B#BC



### Biscayne Patio Table and Chair Set

#### SPECIFICATIONS

- Includes one solid top pedestal table and four portable chairs
- Powder coated finish
- Chairs feature both 1 1/2" and 1" square tubing
- Pre-drilled surface mount holes

PRODUCT NO.: TS36BC-CBC-SET



### Biscayne Geometric Bench with Back

#### SPECIFICATIONS

- 8' length
- Features 4" square tubing supports
- Add SM (surface mount) or S (in-ground mount) to end of product number
- Powder coated finish

PRODUCT NO.: B8WBBCG



### Biscayne Geometric Bench without Back

#### SPECIFICATIONS

- 8' length
- Features 4" square tubing supports
- Add SM (surface mount) or S (in-ground mount) to end of product number
- Powder coated finish

PRODUCT NO.: B8BCG



### Biscayne Trash Receptacle

#### SPECIFICATIONS

- 32 gallon capacity
- Powder coated finish
- Optional second powder coated backing color
- 1" square tubing
- Lid and liner are included
- Portable with mounting kit sold separately

LID STYLE	PRODUCT NO.
Flat Top	TR32BC-FLATTOP
Ash Bonnet	TR32BC-FLATTOPAB
Rain Bonnet	TR32BC-FLATTOPRB



### Acadia Portable Table

#### SPECIFICATIONS

- Powder coated frame, table top, and seats
  - Pre-drilled surface mount holes
  - 36" solid top
  - Features standard umbrella hole
- PRODUCT NO.: TS36AC



### Acadia Bench with Back

#### SPECIFICATIONS

- 4' or 6' lengths available
  - Powder coated finish
  - Heavy-duty 2 3/8" powder coated frame
  - Fully welded
  - Add SM (surface mount) or S (in-ground mount) to end of product number
- PRODUCT NO.: B#WBAC



B6AC

### Acadia Bench without Back

#### SPECIFICATIONS

- 4' or 6' lengths available
- Powder coated finish
- Heavy-duty 2 3/8" powder coated frame
- Fully welded
- Add SM (surface mount) or S (in-ground mount) to end of product number

PRODUCT NO.: B#AC

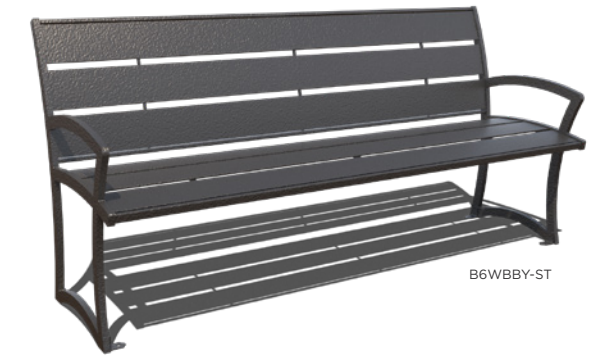

B6WBBY-ST

### Bryce Steel Bench with Back

#### SPECIFICATIONS

- 4', 6', or 8' lengths available
- Features 1/4" x 5" powder coated steel planking
- Features 3/4" powder coated steel plate legs reinforced with 1/4" thick support bars
- Combined portable/surface mount frame with tabs

PRODUCT NO.: B#WBBY-ST

### Bryce Steel Bench without Back

#### SPECIFICATIONS

- Features 1/4" x 5" powder coated steel planking
- Features 3/4" powder coated steel plate legs reinforced with 1/4" thick support bars
- Combined portable/surface mount frame with tabs
- Available with or without armrests

ARMRESTS	LENGTH (#)	PRODUCT NO.
No Armrests	4', 6', 8'	B#BY-ST
Side Armrests	4', 6', 8'	B#BY-ST-ARM



B6BY-ST/B6BY-ST-ARM

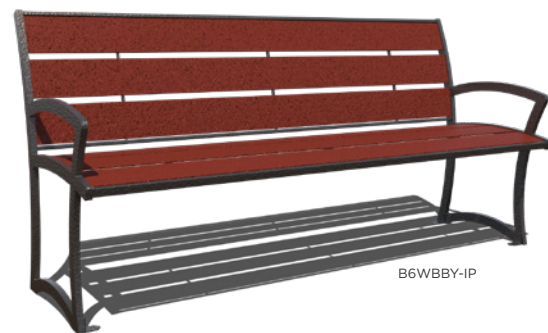

B6WBBY-IP

### Bryce Ipe Bench with Back

#### SPECIFICATIONS

- 4', 6', or 8' lengths available
- Features 1 1/4" x 6", stained Ipe wood planking
- Planks and are cut to length and predrilled
- Planks are sealed on each end to prevent splitting
- Features 3/4" powder coated steel plate legs reinforced with 1/4" thick support bars
- Combined portable/surface mount frame with tabs

PRODUCT NO.: B#WBBY-IP



B6BY-IP-ARM

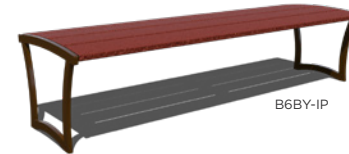

B6BY-IP

### Bryce Ipe Bench without Back

#### SPECIFICATIONS

- Features 1 1/4" x 6", stained Ipe wood planking
- Planks and are cut to length and predrilled
- Planks are sealed on each end to prevent splitting
- Features 3/4" powder coated steel plate legs reinforced with 1/4" thick support bars
- Combined portable/surface mount frame with tabs
- Available with or without armrests

ARMRESTS	LENGTH	PRODUCT NO.
No Armrests	4', 6', 8'	B#BY-IP
Side Armrests	4', 6', 8'	B#BY-IP-ARM



B6WBCC-RC

### Cascades Bench with Back

#### SPECIFICATIONS

- 6' or 8' lengths available
- Recycled planking in your choice of four colors
- 1 1/2" thick cast aluminum frame with textured polyethylene finish
- Stainless steel hardware
- Combined portable/surface mount frame

PRODUCT NO.: B#WBCC-RC



B6CC-RC

### Cascades Bench without Back

#### SPECIFICATIONS

- 6' or 8' lengths available
- Recycled planking in your choice of four colors
- 1 1/2" thick cast aluminum frame with textured polyethylene finish
- Stainless steel hardware
- Combined portable/surface mount frame

PRODUCT NO.: B#CC-RC

### Cascades Trash Receptacle

#### SPECIFICATIONS

- 32 gallon capacity
- 2" x 4" recycled plastic planks in your choice of four colors
- Lid and liner are included
- Portable with mounting kit sold separately

LID STYLE	PRODUCT NO.
Flat Top	TR32CC-FLATTOP
Ash Bonnet	TR32CC-FLATTOPAB
Rain Bonnet	TR32CC-FLATTOPRB

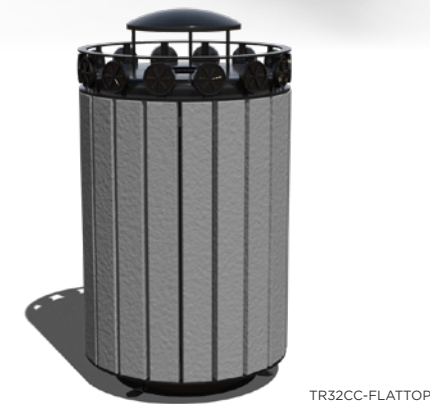

TR32CC-FLATTOPRB



### Gateway Recycled Bench without Back

#### SPECIFICATIONS

- 4' or 6' lengths available
  - 2" x 4" recycled planking in your choice of four colors
  - Powder coated cast aluminum frame
  - Combined portable/surface mount frame
  - Available in 4' and 6' lengths
- PRODUCT NO.: B#GW-RC

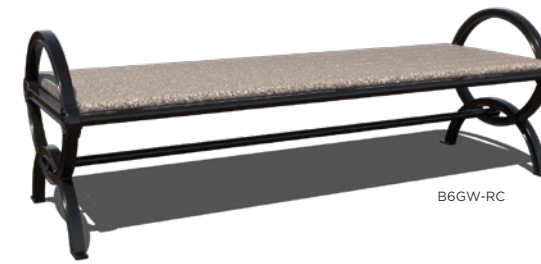

### Samoa Bench with Back

#### SPECIFICATIONS

- 6' length
  - 2" x 2" square tube frame
  - Combined portable/surface mount frame with pre-drilled surface mount holes
  - Powder coated steel
- PRODUCT NO.: B6WBSA



### Arches Steel Bench with Back

#### SPECIFICATIONS

- 6' length
  - Powder coated 3" square tubing legs and steel slats
  - Replace # in product number with SM (surface) or S (in-ground mount)
- PRODUCT NO.: B6WBAR#-ST



### Arches Steel Bench without Back

#### SPECIFICATIONS

- 6' length
  - Powder coated 3" square tubing legs and steel slats
  - Replace # in product number with SM (surface) or S (in-ground mount)
- PRODUCT NO.: B6AR#-ST



### Arches Steel Cantilever Bench

#### SPECIFICATIONS

- 6' length
  - T-cantilever design
  - Features powder coated 4" steel tubing frame and steel slats
  - Add SM (surface) or S (in-ground mount) after "AR" in product number
- PRODUCT NO.: B6AR#-ST-CANT



### Gateway Steel Bench with Back

#### SPECIFICATIONS

- Powder coated finish
- Cast aluminum frame with metal slats
- Available in horizontal or vertical metal slats
- Combined portable/surface mount frame

SLAT DESIGN	PRODUCT NO.	LENGTH (#)
Horizontal	B#WBGW-ST-H	4', 6'
Vertical	B#WBGW-ST-V	4', 6'

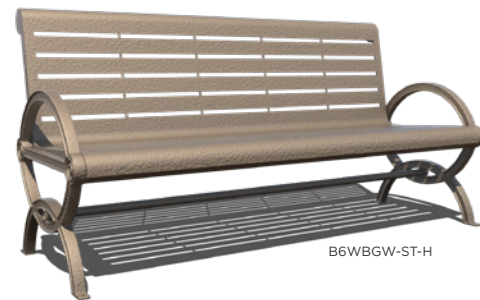

### Gateway Steel Bench without Back

#### SPECIFICATIONS

- 4' or 6' lengths available
  - Powder coated finish
  - Cast aluminum frame with metal slats
  - Combined portable/surface mount frame
- PRODUCT NO.: B#GW-ST-V

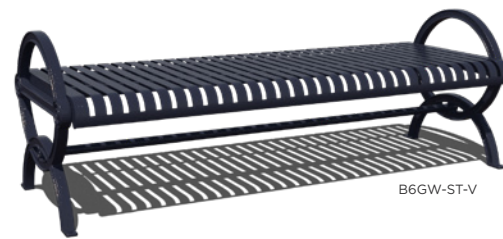

### Gateway Recycled Bench with Back

#### SPECIFICATIONS

- 4' or 6' lengths available
  - 2" x 4" recycled planking in your choice of four colors
  - Powder coated cast aluminum frame
  - Combined portable/surface mount frame
- PRODUCT NO.: B#WBGW-RC

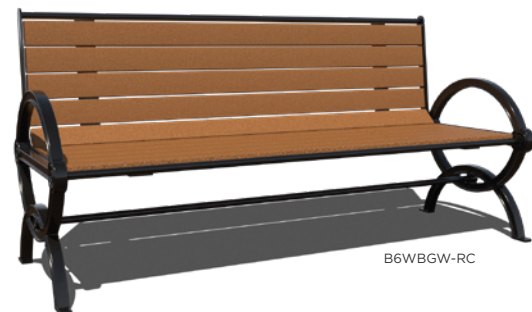



B6WBARSM-RC

### Arches Recycled Bench with Back

#### SPECIFICATIONS

- 6' length
- Powder coated 3" square tubing legs
- Recycled planking in your choice of four colors
- Replace # in product number with SM (surface) or S (in-ground mount)

PRODUCT NO.: B6WBAR#-RC



T6ARSM-RC-CANT

### Arches Recycled Cantilever Table

#### SPECIFICATIONS

- Cantilever design
- 6' table with 4' bench seats
- Features 4" steel tubing powder coated frame
- Recycled planking in your choice of four colors
- Features metal accent tubes
- Replace # in product number with SM (surface) or S (in-ground mount)

PRODUCT NO.: T6AR#-RC-CANT

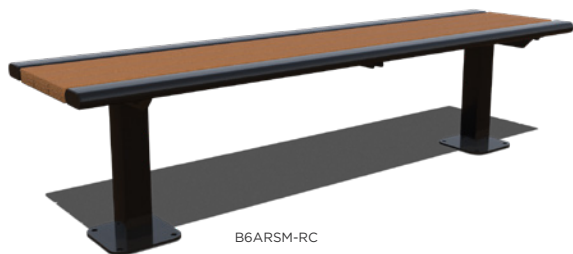

B6ARSM-RC

### Arches Recycled Bench without Back

#### SPECIFICATIONS

- 6' length
- Powder coated 3" square tubing legs
- Recycled planking in your choice of four colors
- Replace # in product number with SM (surface) or S (in-ground mount)

PRODUCT NO.: B6AR#-RC



T6ARPEDSM-ST

### Arches Steel Pedestal Table

#### SPECIFICATIONS

- 6' table with 6' bench seats
- Features powder coated 4" steel tubing frame and steel slats
- Replace # in product number with SM (surface) or S (in-ground mount)

PRODUCT NO.: T6ARPED#-ST



B4ARSM-RC-CANT

### Arches Recycled Cantilever Bench

#### SPECIFICATIONS

- 4' length
- Cantilever design
- Features 4" steel tubing powder coated frame
- Features recycled planking and metal accent tubes
- Add SM (surface) or S (in-ground mount) after "AR" in product number

PRODUCT NO.: B4AR#-RC-CANT



T6ARPEDSM-RC

### Arches Recycled Pedestal Table

#### SPECIFICATIONS

- 6' table with 6' bench seats
- Heavy-duty 2 3/8" powder coated frames
- 2" x 4" recycled planking in your choice of four colors
- Replace # in product number with SM (surface) or S (in-ground mount)

PRODUCT NO.: T6ARPED#-RC



T6AR#-ST-CANT

### Arches Steel Cantilever Table

#### SPECIFICATIONS

- Cantilever design
- 6' table with 4' bench seats
- Features powder coated 4" steel tubing frame and steel slats
- Replace # in product number with SM (surface) or S (in-ground mount)

PRODUCT NO.: T6AR#-ST-CANT



TR32AR-FLATTOPAB

### Arches Recycled Trash Receptacle

#### SPECIFICATIONS

- 32 gallon capacity
- 2" x 4" recycled plastic planks in your choice of four colors with metal accent tubes
- Lid and liner are included
- Portable with mounting kit sold separately

LID STYLE	PRODUCT NO.
Flat Top	TR32AR-FLATTOP
Ash Bonnet	TR32AR-FLATTOPAB
Rain Bonnet	TR32AR-FLATTOPRB



## Aluminum Bleacher COLLECTION

high-quality aluminum bleachers for nearly every capacity



### Low Rise Bleacher

#### SPECIFICATIONS

- 6" vertical rise per row and 24" tread depth between seats
- Row one seat is approximately 11 1/2" in height
- Capacity between 30 to 80 spectators based on selections
- Features 2" x 12" clear anodized seat planks
- Single foot planks

ROW AMOUNT	PRODUCT NO.	LENGTHS (#)
3	BL3XXLR	15', 21', 24'
4	BL4XXLR	15', 21', 24'
5	BL5XXLR	15', 21', 24'



### Tip and Roll Bleacher

#### SPECIFICATIONS

- Tip and roll away for easy storage
- Feature swivel casters and non-marring rubber foot pads
- 6" vertical rise per row and 24" tread depth between seats
- Row one seat is approximately 16" in height
- Capacity between 10 to 48 spectators based on selections
- Features 2" x 10" clear anodized seat planks
- Choose between single or double 2" x 10" foot planks

ROW AMOUNT	PRODUCT NO.	LENGTHS (#)
3	BL3XXTNR	7' 6", 9', 12', 15', 21', 24'



### Non-Elevated Bleacher

#### SPECIFICATIONS

- 6" vertical rise per row on 3 row option and 8" on 5 row and above
- Row one seat is approximately 17" in height
- Capacity between 15 to 200 spectators based on selections
- Features 2" x 10" clear anodized seat planks
- Single foot planks

ROW AMOUNT	PRODUCT NO.	LENGTHS (XX)
3	BL3XXNE	7.5', 12', 15', 21', 24', 27'
5	BL5XXNE	15', 21', 24', 27', 30'
8	BL8XXNE	15', 21', 24', 27', 30'
10	BL10XXNE	15', 21', 24', 27', 30'

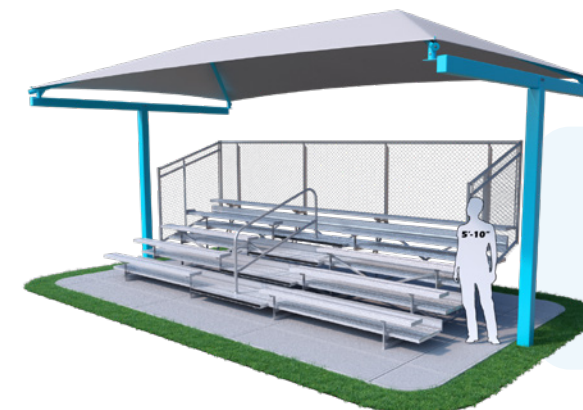

Offering Shades to Accommodate a Variety of Standard Bleacher Sizes

3, 4, 5, 10 Rows  
7.5', 9', 15', 21', 27' Lengths

LEARN MORE AT [SRPSHADE.COM](http://SRPSHADE.COM)





**Dog Park**  
COLLECTION

a complete collection of dog park amenities

62 Benches   63 Trash Receptacles, Drinking Fountains, & Pet Stations  
64 Agility Equipment & Packages



### Fetching More Fun

Experience the joy of worry-free dog park ownership with our low-maintenance dog park equipment. Create a welcoming and enjoyable space for dogs and their owners that lasts, with minimal effort required.

### All Your Dog Park Equipment in One Place



Furniture



Accessories



Agility Equipment

### Why You'll Like Us



#### Natural Look, Virtually No Maintenance

Offers the look and feel of wood without the unwanted maintenance.



#### Certified Green

Our support posts and decking material are certified green through our lumber supplier.



#### Easy to Clean & Maintain

Our dog park products clean easily with a light power wash.



#### Meets USGBC LEED Requirements

Our support posts and decking material meet criteria for LEED requirements.





B6WBULSM  
With Backing  
Plate

**Standard Dog Park Bench**

**SPECIFICATIONS**

- 6' bench
- 2 3/8" powder coated frame
- Add P (portable), SM (surface mount), or S (in-ground mount) to end of product number
- 12" seat width and 17" seat height

PRODUCT NO.: B6WBUL



B6WBCLASSIC

**Classic Dog Park Bench**

**SPECIFICATIONS**

- 6' bench
- Cast aluminum, powder coated frames
- Portable with pre-drilled holes for optional surface mounting
- Contoured back
- 16 1/2" seat height
- Classic wave design

PRODUCT NO.: B6WBCLASSIC



B6WBCLASSICWINGLINES  
With Backing  
Plate

**Classic Wingline Dog Park Bench**

**SPECIFICATIONS**

- 6' bench
- Heavy-duty 2 3/8" powder coated frames
- Add P (portable), SM (surface mount), or S (in-ground mount) to end of product number
- Contoured back with armrests
- 18" seat height

PRODUCT NO.: B6WBCLASSICWINGLINE

Choose Paws or Bone Design

  OR 



TR32 with DOME 32

**Dog Park Trash Receptacle**

**SPECIFICATIONS**

- 32 gallon
- Lid and liner sold separately
- Surface and in-ground mount options sold separately

METAL DESIGN	PRODUCT NO.
Regal	TR32
Perforated	TR32PERF
Classic	TR32CLASSIC



BSW-0007XX

BSW-0010XX

**Dog Park Drinking Fountains**

PET AND OWNER | BSW-0007XX

- Stainless steel
- Meets ADA requirements
- For both humans and pets

PET ONLY | BSW-0010XX

- Stainless steel
- Push-button mechanism
- Anti-rotation non-squirt bubbler



**Leash Holder**

PRODUCT NO.: RECF0022XX



**Pet Wash Station**

**SPECIFICATIONS**

- Stainless steel with green powder coat
- Resistant to sunlight, heat, and moisture
- Surface mount
- Hooks to external hose

PRODUCT NO.: BSW-0011XX



**Pet Waste Station**

**SPECIFICATIONS**

- Features "Pet Waste Station" sign
- Available only in green
- Includes sign, bag dispenser box with key, 2 rolls of bags, 10 gallon waste receptacle, 1 box of liner trash bags, mounting hardware, and mounting post

PRODUCT NO.: BSO-0003

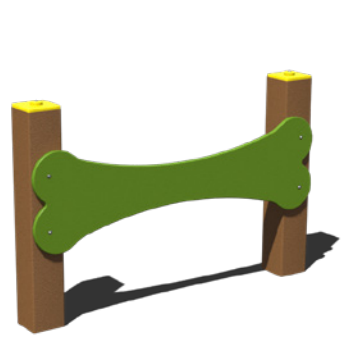

**Over and Under**  
Model: RECF0012XX



**Through the Target**  
Model: RECF0006XX



**Jump Through**  
Model: RECF0014XX

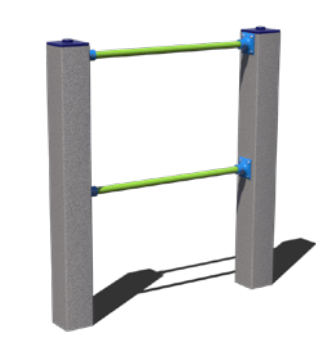

**High Jump**  
Model: RECF0011XX

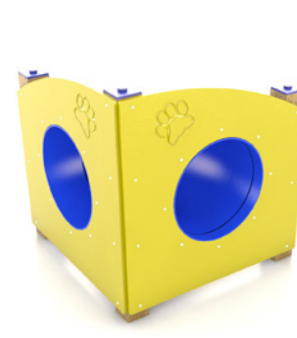

**Nice Turn**  
Model: RECF0013XX

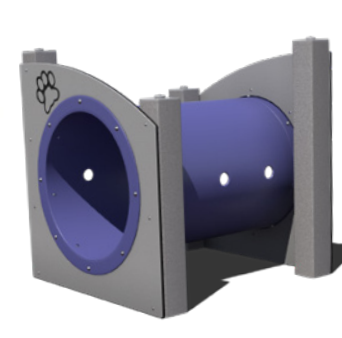

**Dog Log**  
Model: RECF0008XX



**Home Sweet Home**  
Model: RECF0010XX

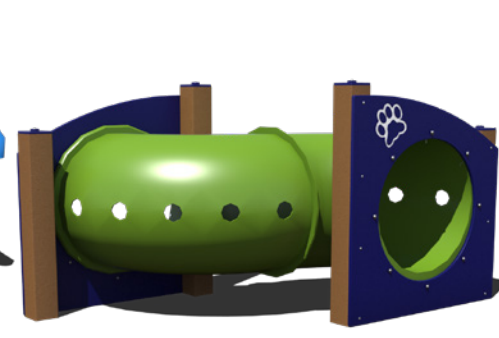

**Through the Tunnel**  
Model: RECF0004XX

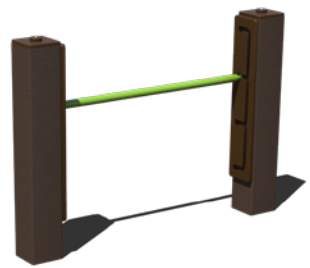

**Limbone, Anyone?**  
Model: RECF0003XX



**Let's Rest**  
Model: RECF0009XX

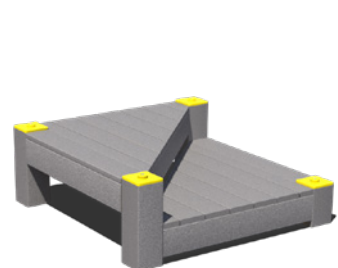

**Climb and Sit**  
Model: RECF0002XX



**Step Up**  
Model: RECF0005XX



**Walk the Plank**  
Model: RECF0015XX

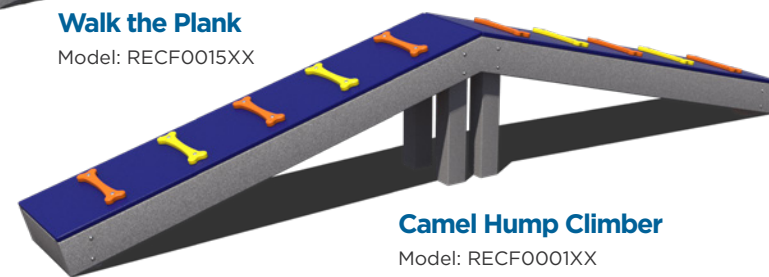

**Camel Hump Climber**  
Model: RECF0001XX



**Hurdle Jump Set**  
Model: RECF0007XX  
Set of 4

  
**Ask Your Representative to See Color Options**

### Puppy Paradise



**FEATURES**

- Beginner course
- Discounted package pricing
- 32' x 37' recommended area
- Package includes Jump Through, Stepping Up, Let's Rest, Camel Hump Climber, Home Sweet Home, and Nice Turn

Model: RECF0018XX



### Pawsitively Playful



**FEATURES**

- Small area course
- Discounted package pricing
- 30' x 27' recommended area
- Package includes Jump Through, Stepping Up, Home Sweet Home, and Nice Turn

Model: RECF0019XX



### Dog's Best Friend



**FEATURES**

- Intermediate course
- Discounted package pricing
- 28' x 33' recommended area
- Package includes Dog Log, Jump Through, Home Sweet Home, High Jump, Stepping Up, and Climb and Sit

Model: RECF0017XX



### Beggin' For More



**FEATURES**

- Large area course
- 35' x 64' recommended area
- Package includes Camel Hump Climber, Through the Tunnel, Home Sweet Home, Dog Log, Jump Through, Let's Rest, Walk the Plank, High Jump, Stepping Up, and Over and Under

Model: RECF0020XX



### Master Companion



**FEATURES**

- Advanced course
- Discounted package pricing
- 44' x 34' recommended area
- Package includes Through the Target, Dog Log, Walk the Plank, Limbone Anyone, Over and Under, and Home Sweet Home

Model: RECF0016XX



### Best in Show



**FEATURES**

- Everything course
- 51' x 52' recommended area
- Package includes all dog play products except Hurdle Jump and Leash Holder

Model: RECF0021XX





## Outdoor Fitness COLLECTION

a collection of fitness equipment designed for ages 13+

69 Modern Fitness Equipment 71 Traditional Fitness Equipment



### Lat Pull Down

Instructional sticker included  
In-Ground: UP165S  
Surface Mount: UP165SM



### Accessible Lat Pull Down

Instructional sticker included  
In-Ground: UP180S  
Surface Mount: UP180SM



### Captain's Chair

Instructional sticker included  
In-Ground: UP167S  
Surface Mount: UP167SM



### Leg Press

Instructional sticker included  
In-Ground: UP170S  
Surface: UP170SM



### Cardio Walker

Instructional sticker included  
In-Ground: UP164S  
Surface Mount: UP164SM



### Hand Cycle

Instructional sticker included  
In-Ground: UP216S  
Surface Mount: UP216SM



### Accessible ADA Hand Cycle

Instructional sticker included  
In-Ground: UP217S  
Surface Mount: UP217SM



### Chest Press

Instructional sticker included  
In-Ground: UP166S  
Surface: UP166SM



### Accessible Chest Press

Instructional sticker included  
In-Ground: UP179S  
Surface: UP179SM



### Sit-Up/Back Extension

Instructional sticker included  
In-Ground: UP168S  
Surface: UP168SM



NEW!

### Cross Training Trapeze Rack

Model: UP231  
Instructional sticker included



NEW!

### 9' Adult Climbing Wall

Model: UP233  
Instructional sticker included



Instructional Sign with Post & Instructional Sticker

Warning! Safety surfacing required for outdoor fitness equipment per ASTM F1292 and F3101-15.



**Recumbent Cycle**  
 Instructional sticker included  
**In-Ground:** UP215S  
**Surface Mount:** UP215SM



**Balance Board Station**  
 Model: UP177  
 Instructional sign with post included



**Push-Up Station**  
 Model: UP224  
 Instructional sticker included



**Horizontal Chin-Up Station**  
 Model: UP183  
 Instructional sign with post included

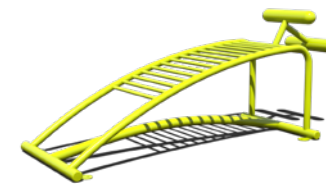

**Sit-Up Bench**  
 Model: AFT13972XX  
**Add-On Instructional Sign**  
 Model: 60019457XX  
*In-Ground Kit Required: FIT14050XX*



**Beam Jump**  
 Model: 60019405XX  
**Add-On Instructional Sign**  
 Model: 60019455XX



**Stretching Post**  
 Model: 60019404XX  
**Add-On Instructional Sign**  
 Model: 60019454XX



**Spring Up Bars**  
 Model: 60019410XX  
**Add-On Instructional Sign**  
 Model: 60019460XX



**Plyometric Box**  
 Instructional sign included  
 Multiple heights available  
 6": UP172    12": UP173  
 18": UP174    24": UP175



**Balance Plank Station**  
 Model: UP176  
 Instructional sign with post included

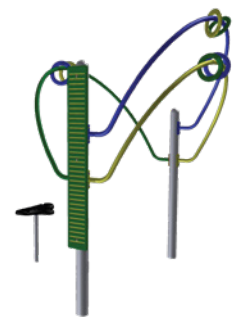

**Skill Trainer**  
 Model: UP354  
 Instructional sticker included



**Energy & Strength Wheels**  
 Instructional sticker included  
**In-Ground:** UP191S  
**Surface Mount:** UP191SM



**Jump Touch Beam**  
 Model: 60019406XX  
**Add-On Instructional Sign**  
 Model: 60019456XX



**Pull Up & Chin Up Bar**  
 Model: 60019403XX  
**Add-On Instructional Sign**  
 Model: 60019453XX



**Pull-Up & Dip Station**  
 Model: AFT14031XX  
**Add-On Instructional Sign**  
 Model: TFR0588XX  
*In-Ground Kit Required: FIT14050XX*

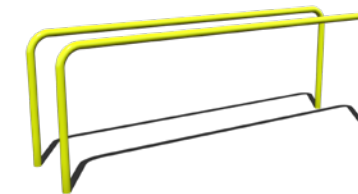

**Parallel Bars**  
 Model: 60019401XX  
**Add-On Instructional Sign**  
 Model: 60019451XX



**Assisted Balance Walk**  
 Model: UP352  
 Instructional sign with post included



**Assisted Step Around**  
 Model: UP355  
 Instructional sticker included



**Assisted Step Trainer**  
 Model: UP353  
 Instructional sign with post included



**Assisted Functional Trainer**  
 Model: UP351  
 Instructional sign with post included



**Balance Beam**  
 Model: 60019408XX  
**Add-On Instructional Sign**  
 Model: 60019458XX



**Horizontal Ladder**  
 Model: 60019409XX  
**Add-On Instructional Sign**  
 Model: 60019459XX



**Vertical Ladder**  
 Model: 60019402XX  
**Add-On Instructional Sign**  
 Model: 60019452XX

**10 Station Course (Not Pictured)**

Model: 60019400XX

Includes:

- Vertical Ladder
- Beam Jump
- Stretching Post
- Pull Up and Chin Up Bars
- Jump Touch Beam
- Parallel Bars
- Sit-Up Bench
- Spring Up Bars
- Horizontal Ladder
- Balance Beam
- 3 Large Instructional Signs



**Instructional Sign with Post & Instructional Sticker**

# Color Options

## Essentials Collection | Textured Polyethylene (Semi-Gloss)

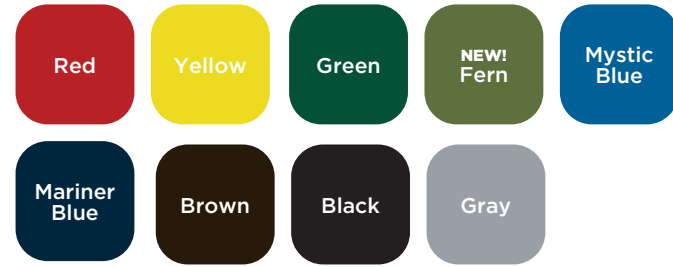

## Basic\* & Essential Collection | Thermoplastic (Glossy)



\*Basic Amenities only available in red, green, blue, and black.

## Powder Coat

### Gloss



### Matte, Textured, or Metallic



## Recycled Uptown Collection | Recycled Planks



## Recycled Collection | Resinwood Slats



# Metal Style Options

## Essential Amenities

**Regal | RC**  
3/4" #9 expanded metal inside a 2" x 2" iron frame

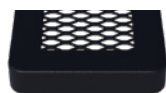

**Perforated | PERF**  
5/8" diameter punched steel with rolled corners

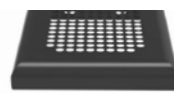

**UPDATED DESIGN!**

**Innovated | INNV**  
1/2" diameter punched steel inside a 2" x 2" iron frame



**Rolled | ROLL**  
3/4" #9 expanded metal with rolled edges



**Classic | CLASS**  
3/4" #9 expanded metal inside ribbed steel with rolled edges



## Basic Amenities

**UltraLeisure\* | UL**  
3/4" #9 expanded metal inside a 1" x 1 7/8" metal strap frame



# Mounting Options



# Warranty

Superior Recreational Products (SRP) warrants that its product will be free from defects in materials and workmanship as well as maintain structural integrity for the periods listed below from the date of invoice and once SRP has been paid in full. This warranty is in effect only if the product has been assembled and installed strictly in accordance with the setup instructions provided by SRP, good construction practices, and has been subjected only to normal use and exposure.

- Lifetime\* Warranty on Stainless Steel Hardware
- 7-Year Limited Warranty on Textured Polyethylene and Thermoplastic
- 5-Year Limited Warranty on Frames and Powder Coat
- 1-Year Limited warranty on moving parts and materials not covered above

The Limited Warranty excludes abnormal conditions, contingent liability, cosmetic defects such as scratches, dents, marring, stripping, peeling, or fading; damage due to incorrect installation, vandalism, misuse, accident wear and tear from normal use; exposure to extreme weather, immersion in salt or chlorine water, damage due to sand, salt spray, or other abrasive and corrosive material; unauthorized repair or modification, abnormal use, or lack of maintenance. The warranty does not cover damages due to "acts of God" such as hail, flooding, lightning, tornadoes, sand storms, shifts of terrain, earthquakes, mud slides, and windstorms. SRP does not warrant product for defects caused by erection, harsh site conditions, lack of maintenance, and/or other conditions beyond SRP's control. SRP will not be held responsible for any materials that were not properly stored prior to installation. SRP reserves the right to void the limited warranty if it not installed per the installation instructions and/or unauthorized modifications.

In the unlikely event of failure, SRP reserves the right to alter the design, color, or contributing factors to rectify the condition and help prevent any future reoccurrence(s). SRP has the option to repair or replace any defect in materials.

The warranty is void if any changes, modifications, additions, or attachments are made to the product without the written consent of the manufacturer.

SRP excludes any implied warranty of merchantability, fitness, or purpose, and there are no warranties which extend beyond the description of the face hereof. Under no circumstances will SRP be responsible for any indirect, special, consequential, incidental, or liquidated damages due to breach of warranty and such damages are specifically excluded from the warranty.

The owner shall notify SRP with original Sales Order Number issued from SRP to arrange for an inspection within 30 days after discovery of any defect under this warranty and before any alteration or repair is made or attempted. This Limited Warranty shall be null and void if the owner makes any alterations in design.

This warranty is the only express warranty given by the company. No person has authority to change or add to these obligations and liabilities. The company reserves the right to determine whether the fault is caused by faulty workmanship, material, or the part that is defective.

\*For the purpose of this warranty, lifetime encompasses no specific term of years, but rather that seller warrants to its original customer for as long as the original customer owns the product and uses the product for its intended purpose that the product and all parts will be free from defects in materials and manufacturing workmanship. This warranty does not cover damage caused by vandalism, misuse or abuse, altered or modified parts, or cosmetic damage such as scratches, dents, or fading or weathering and normal wear and tear. This warranty is valid only if the structures are installed in conformity with instructions provided by Superior Recreational Products using approved Superior Recreational Products parts. Superior Recreational Products will deliver the repaired or replacement part or parts to the site free of charge, but will not be responsible for labor or the labor costs of replacement. Warranty claims must be filed within the applicable warranty period and accompanied by a sales order or invoice number.



analog by atkore

SRP will repair or replace at its discretion any defective part/s on an Ex-Works basis only. It is the responsibility of the customer to return the whole unit or the defective part/s at their own cost back to SRP for inspection along with proof of the date of purchase. SRP will not be liable for any costs incurred by the customer as a result of replacing the defective part/s, including but not limited to the costs of site visits and the labor costs involved with the removal and reinstallation of the whole unit or the defective part/s. Furthermore SRP will not be liable for any claimed compensation while the unit is not working or not present at the site whatsoever. This guarantee does not entitle the customer to a complete new product due to a defective component.

**Structural Steel** SRP offers a 5-year limited warranty on structural supports for tables and benches to the original purchaser to be free of rust outs that would compromise structural integrity. Workmanship is warranted for a period of five years. This steel warranty shall be void if damage to the steel is caused by the installer or from physical damage, damage by salt spray or sprinkler systems, contact with chemicals, chlorine, pollution, misuse, vandalism, or any act of God.

**Powder Coat** SRP offers a 5-year Limited Warranty for powder coating to the original purchaser. This Limited Warranty is for factory applied finish only. Damage occurring from shipping, erection, vandalism, accidents, or field modification is not covered in this limited warranty and will require field touch-up immediately and periodically thereafter. The owner must report any defect in powder coat at the time the installation is completed. Not covered by this Limited Warranty are acute angles, welds, and end plates.

The Limited Warranty for powder coating provides the following after a 5-year exposure period when applied according to the recommendations listed on the product's technical data sheet and appropriate surface preparation has been utilized.

- The coatings shall retain their original color with a ΔE of <7.5 units for high chroma colors (yellows, reds, oranges, etc.) and a ΔE of <5.0 units for low chroma colors, when tested in accordance with ASTM D 2244.
- The coating shall retain a minimum of 50% of its original gloss level after washing, when tested in accordance with ASTM D 523.
- The coating shall exhibit chalking no worse than numerical rating of 6, when evaluated in accordance with ASTM D 659-80.

**Textured Polyethylene & Thermoplastic** SRP offers a 7-year limited warranty to the original purchaser of the products to be free of corrosion on seats and tops that results in bare metal exposure after the date of purchase, excluding any corrosion that may be the result of vandalism or intentional stripping of any of the coating.

**Pricing, Cancellation, and Shipping Policy** All prices are F.O.B. factor and do not include freight, installation, shipping and handling, surfacing, or applicable taxes. All prices listed were current at the time of printing and in U.S. currency. Prices are subject to change without notice. To view our return policy, please visit [superiorrecreationalproducts.com/returns](http://superiorrecreationalproducts.com/returns). To view our shipping policy, please visit [superiorrecreationalproducts.com/shipping-policy](http://superiorrecreationalproducts.com/shipping-policy). For further information any further information please call 1.800.327.8774.

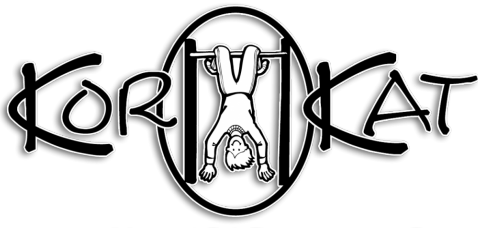

PLAYGROUNDS & SITE AMENITIES

## KORKAT

221 CABLE INDUSTRIAL WAY  
CARROLLTON, GA 30117

[SALES@KORKAT.COM](mailto:SALES@KORKAT.COM)

1-888-356-7528

